

SINGER
33K57

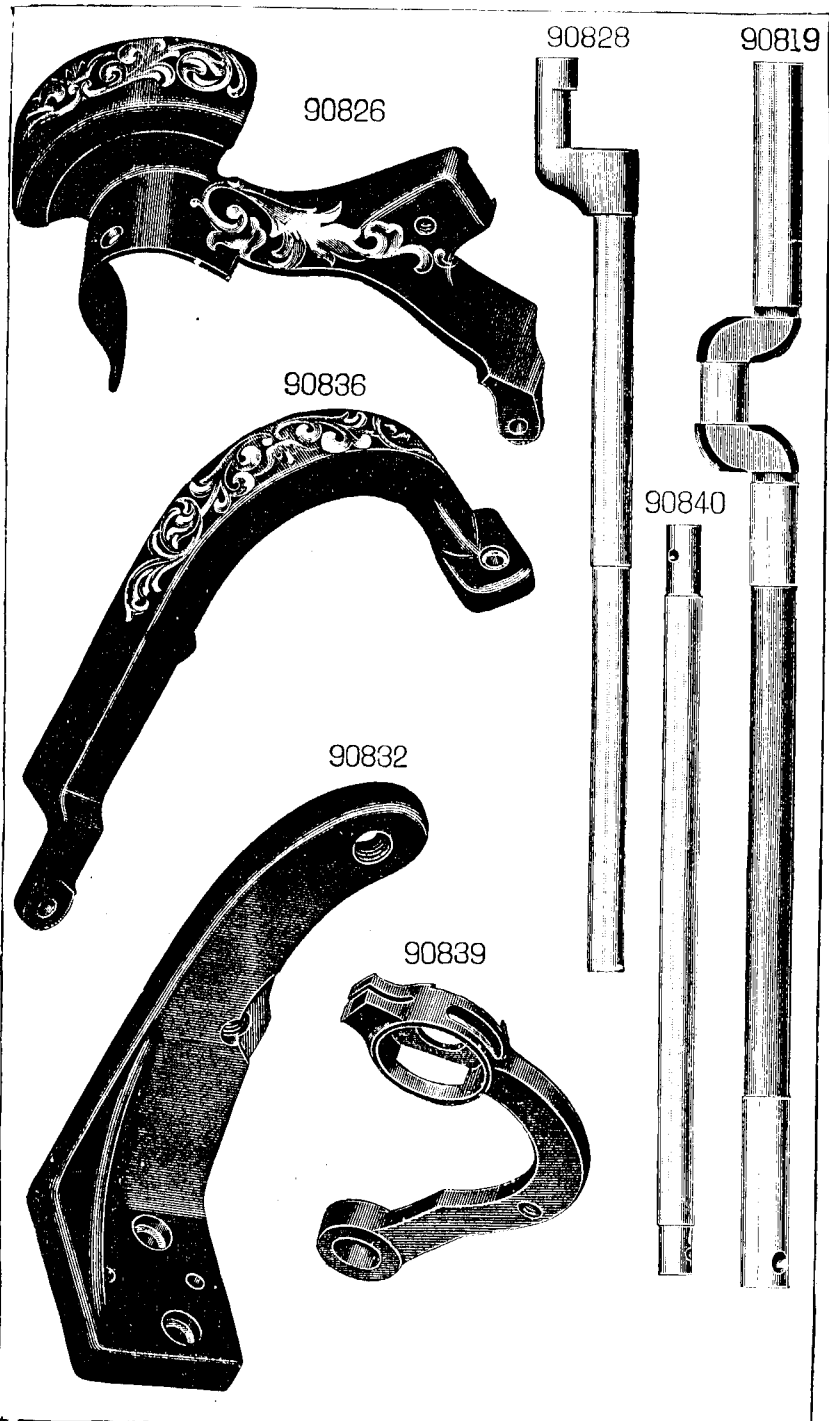

Form K1389.
1913.

ILLUSTRATED PRICE LIST OF PARTS

FOR

No. 33K57 MACHINE

DROP FEED, FOR "RIDERS EDGE STITCH"
ON THREAD DRAWN WORK.

FEB 25 1913

THE SINGER MANUFACTURING COMPANY.

1913.

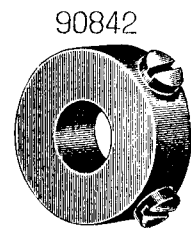
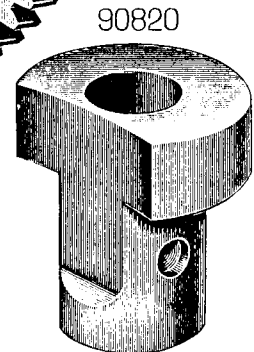
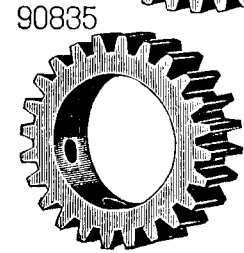
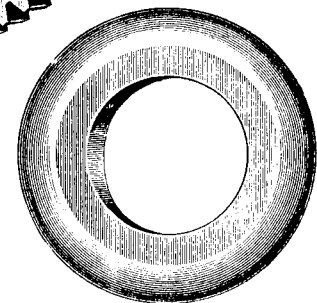
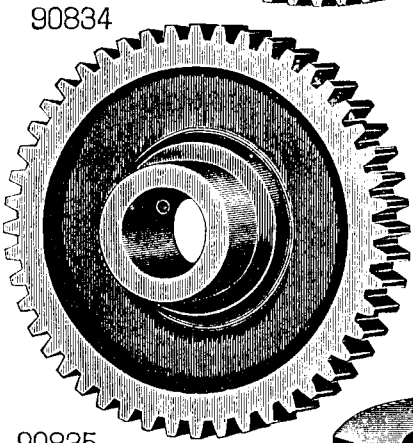
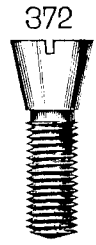
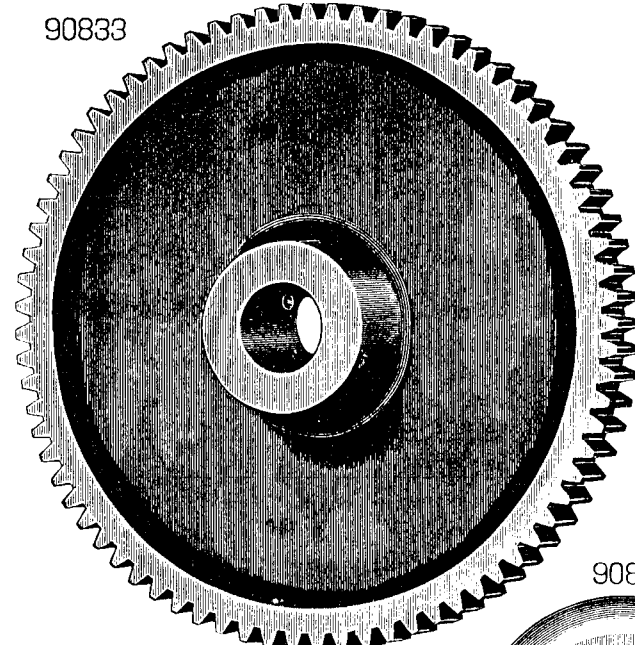
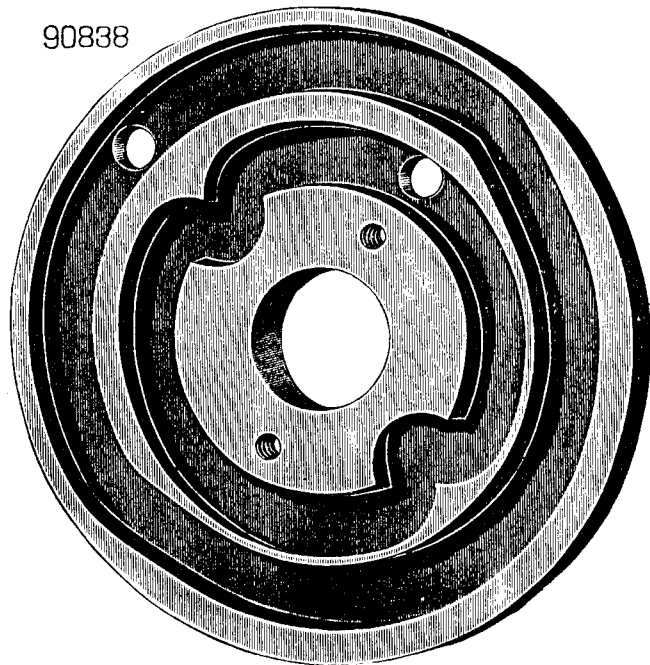
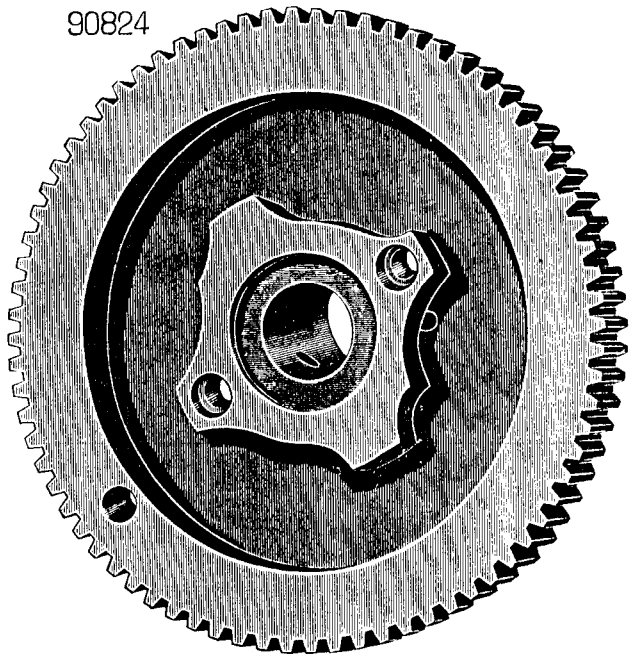

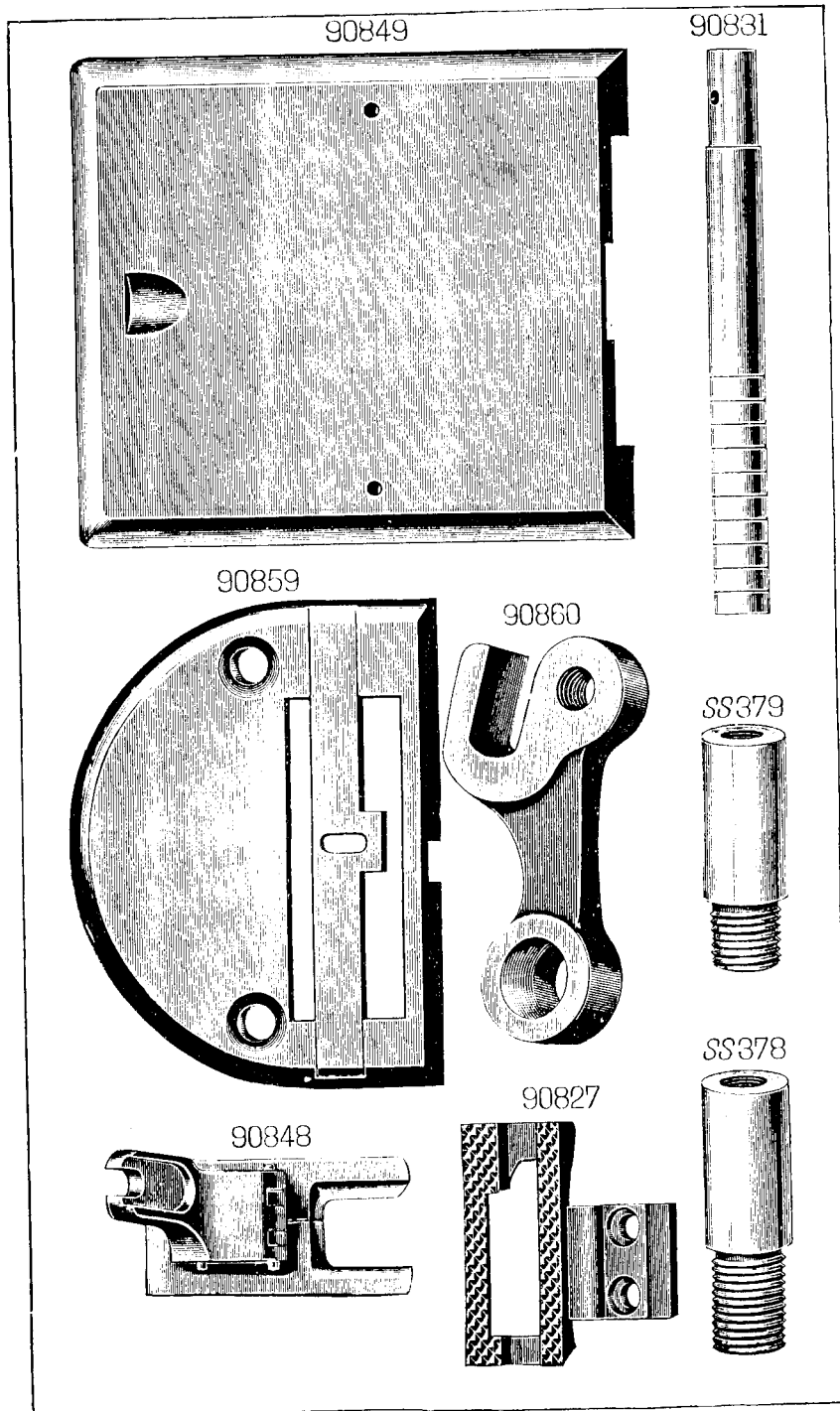
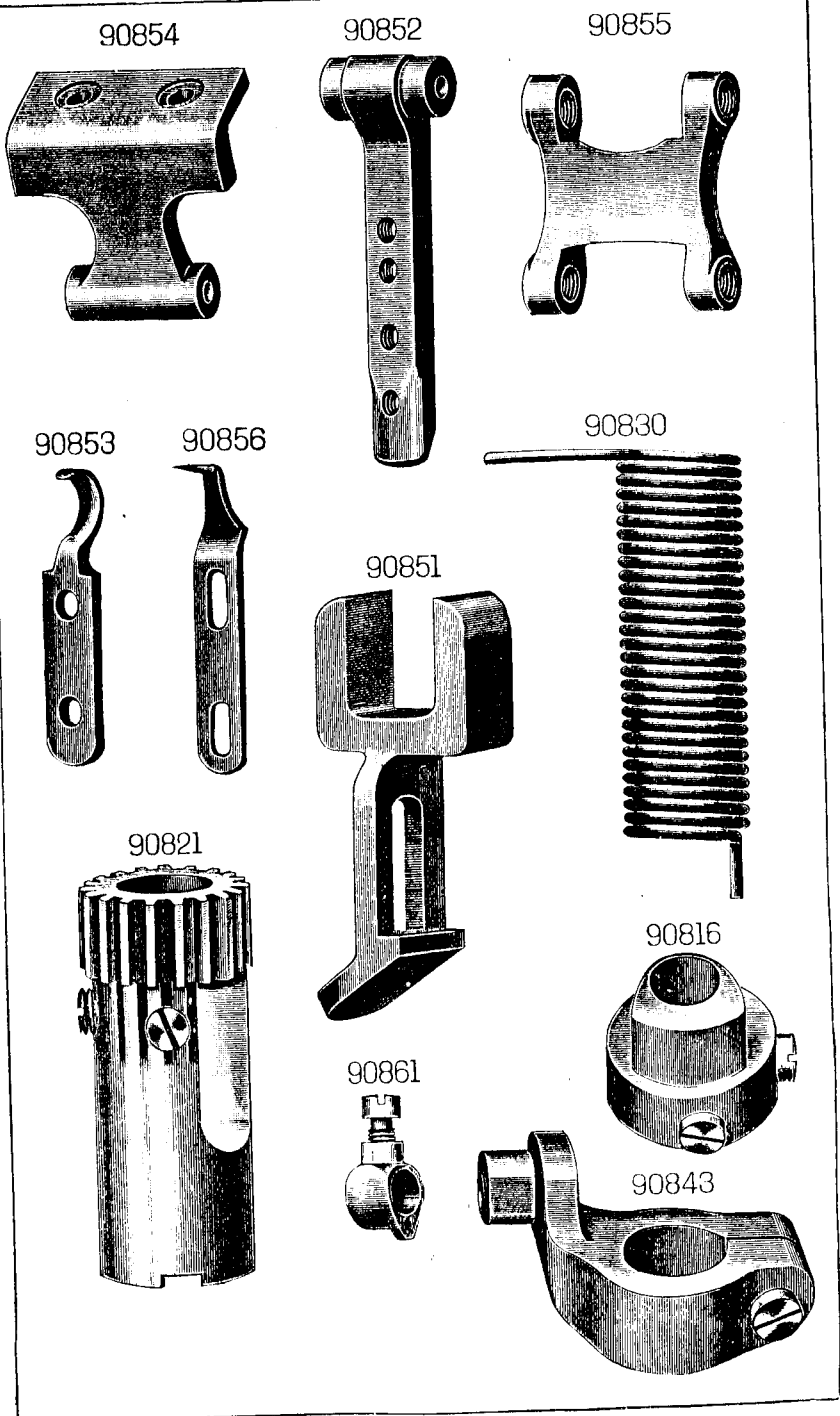

NEEDLES BEST ADAPTED

FOR

No. 33K57 MACHINE.

MACHINE.	NEEDLES.	REMARKS.
33K57	33 × 1	

CONTENTS.

	PAGES
Accessories	19
Bobbin Winder	19
Knee Lifter	19
Numerical List of Parts	21 to 30
Parts Complete	11 to 18

No.	Plate	Description	Price
375c	—	Crank Connecting Rod Hinge Screw ...	4
1518c	—	" " " " " " Nut ...	2
90669	—	Face Plate ...	6 6
90670	—	Face Plate , complete, Nos. 233d, 448c, 600, 4500l, 2108, 2124, 2127, 8238, 90568, 90570, 90669 and two 2102 <i>16202</i>	8 6 <i>4/46</i>
315f	—	Face Plate Screw Centre (2) ...	2
1519e	—	" " " " Nut (2) ...	1 1/2
90815	—	Feed Bar ...	2 6
90512	—	" " Retaining Spring ...	3
190c	—	" " " " Screw ...	1 1/2
314c	—	" " Screw Centre (2) ...	2
1519e	—	" " " " Nut (2) ...	1 1/2
90513	—	Feed Bell Crank with 1813 ...	2 0
7d	—	" " " Hinge Screw ...	10
1813	—	" " " Roller and Stud ...	10
90824	944	Feed Cam Gear ...	8 0
152f	—	" " " Screw ...	1 1/2
SS268c	—	" " " Stud ...	1 3
1513e	—	" " " Nut ...	2
90672	—	" " " Washer ...	4
<i>SS578F 1844</i>	—	" " " " Screw <i>SEP 1932</i> ...	2
90825	—	" " " 90824 with <i>SS268c, 1513e, 90672, 90838</i> and two 152f <i>SEP 1932</i>	14 0
90826	943	" " " Cover ...	3 9
145f	—	" " " Screw (long) ...	2 <i>12/33</i>
159f	—	" " " (short) ...	1 1/2
90676	—	Feed Connection ...	4 2
90677	—	" " 90676 with two each 1519e and 19449	8 4
8569	—	" " Pin ...	1
19448	—	" " Slide Block ...	1 5 <i>12/24</i>
<i>254d 223d</i>	—	" " " Cap Screw ...	1
12424	—	" " " Washer ...	1
988c	—	" " " Screw Stud ...	7 1/2
1519e	—	" " " Nut ...	1 1/2
19449	—	Feed Connection Slide Block , complete, Nos. 223d <i>226d</i> , 988c, 12424 and 19448 <i>12/24</i>	2 0
90827	947	Feed Dog ...	2 6
208ae	—	" " Screw <i>(2)</i> ...	1 <i>10/35 12/49</i>
90729	—	Feed Lifting Bell Crank Lever with 1872 ...	3 3
90522	—	" " " " Connection with two 175c ...	2 0

No.	Plate	Description	Price
175c	—	Feed Lifting Bell Crank Lever Connection Screw ...	1
27c	—	" " " " " " Hinge Screw ...	5 <i>12/25</i>
1520aR	—	" " " " " " Hinge Screw Nut ...	1 1/2
1872	—	" " " " " " Roller and Stud ...	10
307c	—	" " " " " " Screw Centre ...	3
1513c	—	" " " " " " Nut ...	2
90828	943	Feed Lifting Rock Shaft ...	1 3
90829	—	" " " " 90828 with 90681 ...	5 2
27c	—	" " " " Connection Hinge Screw ...	5
90680	—	" " " " Crank with 157c ...	1 9
90681	—	" " " " 90680 with 1519e and 19449	3 11
157c	—	" " " " Clamping Screw ...	2
19418	—	" " " " Slide Block ...	1 5
<i>282d 223d</i>	—	" " " " Cap Screw ...	1 <i>11/19</i>
12424	—	" " " " " " Cap Screw Washer ...	1
988c	—	" " " " " " Block Screw Stud ...	7 1/2
1519e	—	" " " " " " Stud Nut ...	1 1/2
19449	—	" " " " " " complete, Nos. 323d <i>326d</i> , 988c, 12424 and 19448 <i>12/24</i>	2 0
90830	946	" " " Rock Shaft Spring ...	8
90535	—	" " " " Collar ...	2 6
207f	—	" " " " Screw ...	1
307c	—	" " " " Screw Centre (2) ...	3
1513c	—	" " " " Nut (2) ...	2
90831	947	Feed Regulator Bar ...	3 0
193f	—	" " " Binding Screw ...	1 1/2
90528	—	" " " Swivel ...	9
166d	—	" " " Stop Screw ...	3 1/2
SS192d	—	" " " Thumb Screw ...	3
90682	—	Feed Rock Shaft ...	1 6
90683	—	" " " 90682 with 90533 ...	3 9
90533	—	" " " Crank with 207c ...	2 3
8575	—	" " " Pin ...	1
207c	—	" " " Set Screw ...	1
307c	—	" " " Screw Centre (2) ...	3
1513c	—	" " " Nut (2) ...	2
90684	—	" " " Spring ...	8
90535	—	" " " Adjusting Collar ...	2 6
207c	—	" " " " Screw ...	1
190c	—	" " " Screw ...	1 1/2

No.	Plate		Price
90832	943	Intermediate Gear Bracket ...	2 6
SS45d	---	" " " Binding Screw (2) ...	1 1/2
91824	---	" " " Dowel Pin (2) ...	2
90833	945	" " (upper) (76 teeth) ...	5 6
90834	945	" " (lower) (48 teeth) ...	5 0
90835	945	" " (") with two 460c (24 teeth) ...	4 0
460c	---	" " (") Set Screw ...	1
90836	943	" " Cover ...	1 6
159f	---	" " Screw ...	1 1/2
SS378c	947	" " Screw Stud (long) ...	9
SS379c	947	" " " " (short) ...	7
1512c	945	" " " " Nut for SS378 ...	3
90672	---	" " " " Washer ...	4
SS518F164f	---	" " " " Screw SEP 1932	2
90837	---	Intermediate Gearing , complete, Nos. SS378c, SS379c, 1512c, 90832 to 90835, two each 1512c and 90672	19 6 SEP 1932
90536	---	Needle Bar ...	1 9
90685	---	" " Connection Stud with 155c ...	1 0
155c	---	" " " " Set Screw ...	1 1/2
90686	---	" " Connecting Link ...	1 0
380c	---	" " " " Hinge Screw ...	5
1520c	---	" " " " " " Nut ...	1 1/2 12/25
90687	---	" " Guide Bracket with 400c and 456c ...	1 0
400c	---	" " " " Adjusting Screw ...	1
456c	---	" " " " Set Screw ...	1
90861	946	Needle Clamp with 196f ...	6
196f	---	" " Screw ...	1
90688	---	Needle and Shuttle Vibrating Lever ...	10 0
90689	---	" " " " " Cap ...	6
193d	---	" " " " " Screw ...	1 1/2
90860	947	" " " " " Differential Link ...	2 0
372c	945	" " " " " Hinge Screw ...	6
1518e	---	" " " " " Differential Link ...	
		" " " " " Hinge Screw Nut ...	2
64c	---	" " " " " Hinge Screw ...	6
180f	---	" " " " " Binding Screw ...	
		" " " " " (to fasten to face plate) ...	1 1/2
19448	---	" " " " " Lever Slide Block ...	1 5 12/24
326d	---	" " " " " Cap ...	
		" " " " " Screw ...	1
12424	---	" " " " " Cap ...	
		" " " " " Screw Washer ...	1
988c	---	" " " " " Slide Block ...	
		" " " " " Screw Stud ...	7 1/2
1519c	---	" " " " " Block ...	
		" " " " " Screw Stud Nut ...	1 1/2

No.	Plate		Price
19449	---	Needle and Shuttle Vibrating Lever Slide Block , complete, Nos. 226d , 988c, 12424 and 19448	2 0 12/24
90838	944	Needle Side Shift Cam ...	4 0
90839	943	" " " Adjustment Regulator Yoke ...	5 6
90692	---	" " " " " " Guide Bracket ...	9
207f	---	" " " " " " Yoke Guide Bracket Screw (2) ...	1
568c	---	" " " " " " Yoke Hinge Screw ...	7 1/2
1513c	---	" " " " " " Yoke Hinge Screw Nut ...	2
RR56	---	" " " " " " Yoke Roller and Screw Stud ...	1 0
1519e	---	" " " " " " Yoke Roller and Screw Stud Nut ...	1 1/2
90693	---	" " " " " " Regulator Yoke Regulating Disc ...	2 6
164f	---	" " " " " " Yoke Regulating Disc Screw ...	2
4304	---	Oscillating Rock Shaft (Steel, hardened) with 4784 ...	4 2
3052	---	" " " " " Hinge Pin ...	2 0
1513e	---	" " " " " " Nut ...	2
635c	---	" " " " " " Screw Bearing ...	4
1513c	---	" " " " " " " " Nut ...	2
4784	---	" " " " " " Oil Pad ...	1 1/2
90840	943	Oscillating Shuttle Shaft ...	1 0
90841	---	" " " " " 90840 with 90696 ...	4 9
90842	945	" " " " " Collar with two 193f ...	1 0
193f	---	" " " " " " Set Screw ...	1 1/2
90695	---	" " " " " Crank with 460c ...	1 6
90696	---	" " " " " " 90695 with 1519c and 19449 ...	3 9
2049	---	" " " " " " Pin ...	1 1/2
460c	---	" " " " " " Set Screw ...	1
19448	---	" " " " " " Slide Block ...	1 5 12/24
326d	---	" " " " " " " Cap ...	
		" " " " " " Screw ...	1
12424	---	" " " " " " " Cap ...	
		" " " " " " Screw Washer ...	1
988c	---	" " " " " " Block Screw ...	
		" " " " " " Stud ...	7 1/2
1519c	---	" " " " " " " Screw ...	
		" " " " " " Stud Nut ...	1 1/2
19449	---	Oscillating Shuttle Shaft Crank Slide Block , complete, Nos. 226d , 988c, 12424 and 19448	2 0 12/24

No.	Plate	Description	Price
90843	946	Oscillating Shuttle Shaft Vibrating Yoke with 159f and 90844	3 9
159f	—	" " " " " Clamping Screw	1 1/2
90844	—	" " " " " Slide Block and Stud	9
15257	—	Presser Bar	1 3
2068	—	" " Spring Bracket with 453c	1 0
453c	—	" " " " " Set Screw	1
2821	—	" " " " " Lifter	10
689c	—	" " " " " Hinge Screw	5
15204	—	" " " " " Nut	1 1/2
80011	—	" " " " " Spring	2 1/2
2070	—	" " " " " Washer	1 1/2
263d	—	" " " " " Thumb Screw	10
90577	—	Presser Foot Bracket	4 3
90758	—	" " Retaining Sole	2 3
90579	—	" " " " " Pin	1 1/2
90580	—	" " " " " Spring	1
90741	—	" " Sole	2 3
90582	—	" " " " " Pin	1 1/2
90583	—	" " " " " Spring	1
90742	—	" " " " " Position Spring	1
335d	—	" " " " " Screw	1
793d	—	" " " " " Thumb Screw	4
90759	—	Presser Foot (Hinged), Double, complete (for first seam), Nos. 335d, 90577, 90579, 90580, 90582, 90583, 90741, 90742 and 90758	10 0
90845	—	Presser Foot Bracket	4 3
90846	—	" " Sole (right)	2 6
90847	—	" " " (left)	2 6
90579	—	" " " " " Pin	1 1/2
90580	—	" " " " " Spring	1
90848	947	Presser Foot (Hinged), Double, complete (for second seam), Nos. 90845 to 90847, two each 90579 and 90580	10 0
2996	—	Shuttle Bobbin	2 1/2
15140	—	" " Case Latch	5
2973	—	" " " " " Lever	5
2974	—	" " " " " Fulcrum Pin, per 100	5
2975	—	" " " " " Spring	1
592c	—	" " " " " Stop Screw	1
15141	—	" " " " " Hinge, complete, Nos. 2973, 2974 and 15140	1 0
15027	—	" " " " " Position Finger	2 1/2
2523	—	" " " " " Rivet, per 100	1 0
15277	—	Shuttle Bobbin Case, complete, Nos. 591f, 592c, 2975, 15027, 15141 and 15278	3 0

12/25

7/39

7/39

7/47

No.	Plate	Description	Price
22169	—	Shuttle Body	3 0
15278	—	" Tension Spring	5
591f	—	" " Regulating Screw	1
90734	—	Shuttle (Solid) 1 1/8" diam., complete, Nos. 2996, 15277 and 22169	6 3
22171	—	Shuttle Driver	4 2
22172	—	" " 22171 with two 462AL	4 2
2049	—	" " Pin	1/2
462AL	—	" " Set Screw	1
90814	—	Shuttle Race Body	4 6
145P	—	" " " Screw	2
90563	—	" " Back	1 6
2532	—	" " " Position Pin, per 100	5
2533	—	" " " Spring	6
648d	—	" " " " Screw	3 1/2
90744	—	" " Cap	8
662d	—	" " " Screw	1
648d 90844	—	Shuttle Race, complete, Nos. 648d, 90563, 90744, 90814, two each 662d and 2532	7 6
90566	—	Shuttle Race Carrier	5 0
90849	947	Shuttle Race Slide	1 6
90596	—	" " " Spring Catch (left)	1/2
90597	—	" " " " " (right)	1/2
240d	—	" " " " " Screw	1
90850	—	Shuttle Race Slide, complete, Nos. 90596, 90597, 90849 and two 240d	1 9
600	—	Tension Screw Stud (for Face Plate)	5
448c	—	" " " Set Screw	1 1/2
1560d	—	" " " Thumb Nut	2
2102	—	" Disc	2 1/2
8238	—	" Spring	2 1/2
16202	—	" Screw Stud 600 with 1560d	2 1/2
418d	—	Tension Screw Stud (fixed on top of Arm)	4
1562d	—	" " " Thumb Nut	2
2455	—	" Disc	1
10141	—	" Spring	1/2
8620	—	" Thread Guide	1
90568	—	Thread Eyelet	1
2108	—	Thread Guard	1/2
90853	946	Thread Divider Cap	1 0
207f	—	" " " Screw	1
90602	—	" " " Hinge Bar	3 0

4/49

12/33

12/49

3/48

12/49

1/46

No.	Plate		Price
90852	946	Thread Divider Hinge (Male) ...	2 0
90854	946	" " " Link Bracket ...	1 6
207f	—	" " " " " Screw ...	1
90855	946	" " Link ...	1 6
316b	—	" " " Screw Centre ...	1 1/2
1575b	—	" " " " " Nut ...	1 1/2
90747	—	" " Rocking Frame ...	5 0
90816	946	" " " " " Cam with two 193f ...	2 0
193f	—	" " " " " Screw ...	1 1/2
90851	946	" " " " " Fork ...	2 0
90842	945	" " " " " Collar with two 193f ...	1 0
193f	—	" " " " " " " Set Screw ...	1 1/2
SS309d	—	" " " " " Thumb Screw ...	3
90856	946	" " Spur ...	2 6
219f	—	" " " Screw ...	1
90857	—	Thread Divider, complete, Nos. 90602, 90852 to 90856, two 219f, four each 207f, 316b and 1575b	11 6
193f	—	Thread Divider Screw (2) ...	1 1/2
15275	—	Thread Take-up Cam (Steel) with 448c and 1293c ...	4 2
448c	—	" " " Set Screw ...	1 1/2
1293c	—	" " " Timing Screw ...	5
90862	90569	Thread Take-up Lever with 1822 ...	2 0
50527	79c	" " " Hinge Screw ...	3
1822	—	" " " Roller and Stud ...	10
2124	—	Thread Take-up Spring ...	1 1/2
2127	—	" " " Regulator Plate ...	1 1/2
233d	—	" " " " " " Screw ...	1
90570	—	Thread Take-up Staple ...	1/2
90753	—	Throat Plate ...	4 6
90858	—	" " Rib (adjustable) ...	1 0
233d	—	" " " (") Screw ...	1
90859	947	" " complete, Nos. 90753, 90858 and two 233d	5 6
691f	—	" " Screw ...	2
87317	—	Drip Pan ...	10
*15404	—	Trade Mark
15405	—	" " Rivet

12/34
3/33

12/32

Accessories.

No.	Plate		Price
2996	—	Bobbins (5) ^{3/31} ...	2 1/2
35676	—	Oiler with 35678 ...	2 1/2
35678	—	" Spout, 2" long ...	1/2 ^{3/10}
25537	—	Screw Driver (Machine) ...	2
25538	—	" " (Shuttle Tension) ...	2
36569	—	Oiler with 36571 ...	2 1/2
36571	—	" Spout, 1 1/4" long ...	1/2

Bobbin Winder.

2466	—	Eccentric ...	7 1/2
5053F 280	—	" Thumb Screw ...	5 ^{2/34}
90806	—	Frame ...	9
180d	—	" Screw ...	1 1/2
90807	—	Spindle with 15072 ...	6
15072	—	" Bobbin Position Pin, ... per 100	5
8371	—	" Pulley ...	4
2460	—	" " Rubber Ring ...	1
90808	—	Bobbin Winder (Eccentric), complete, Nos. 2466 , 2460, 2466, 8371, 90806 and 90807	2 6 ^{2/34}

Knee Lifter.

90817	—	Arm Lever ...	10
694d	—	" " Hinge Screw ...	7 1/2
12243	—	Bell Crank Lifting Lever ...	7 1/2
80203	—	" " " " 12243 with 6337 ...	1 3
6337	—	" " " " Bracket with two 356c ...	10
356c	—	" " " " " Set Screw ...	3
2767	—	Knee Plate with 356c ...	9
356c	—	" " Set Screw ...	3
80204	—	" " Arm ...	5
2766	—	" " " Bracket with 356c ...	7 1/2
356c	—	" " " " Set Screw ...	3
90809	—	Presser Bar Bracket with 453c ...	9
453c	—	" " " Set Screw ...	1
2763 80208	—	Rock Shaft ...	5 ^{8/33}
80262	—	" " 80208 with 2766, 2767, 80203 and 80204 ...	3 4
97502 80200	—	" " Bracket ...	4 ^{11/28}
—	—	" " Wood Screw (4) 1" No. 10, per doz.	—
90810	—	Knee Lifter, complete, Nos. 694d, 80262, 90809, 90817, two 80200 , and four Wood Screws 1" No. 10	7 0

97502