

PARTS INFORMATION

NO.001 02/25/93

AU2803A-132 GEAR HEAD

AU2803A-132F

ORIENTAL  
4GK5K

AU2803A-132J

ORIENTAL  
4GN5K

REMARK: WHEN ORDERING, PLEASE GET A INFORMATION FROM THE CUSTOMER WHICH NUMBER IS INDICATED ON THEIR PART, 4GK5K OR 4GN5K.

**PARTS INFORMATION**

NO.002 02/25/93

**AU2803A-133 MOTOR**

**AU2803A-133F**

ORIENTAL  
41K25RGK-A2

**AU2803A-133J**

ORIENTAL  
41K25RGN-A

REMARK: WHEN ORDERING, PLEASE GET A INFORMATION FROM THE CUSTOMER WHICH NUMBER IS INDICATED ON THEIR PART, 41K25RGK-A2 OR 41K25RGN-A.

PARTS INFORMATION

NO.003 02/25/93

AU2803A-237 ROTOR CYLINDER

AU2803A-237F

SMC  
CRB32-180

AU2803A-237J

SMC  
CRB1BW30-180S

REMARK: WHEN ORDERING, PLEASE GET A INFORMATION FROM THE CUSTOMER WHICH NUMBER IS INDICATED ON THEIR PART, CRB32-180 OR CRB1BW30-180S.

PARTS INFORMATION

NO.004 02/25/93

AU2803A-238 ROTOR CYLINDER BRACKET

AU2803A-238F

"4" SCREW HOLES

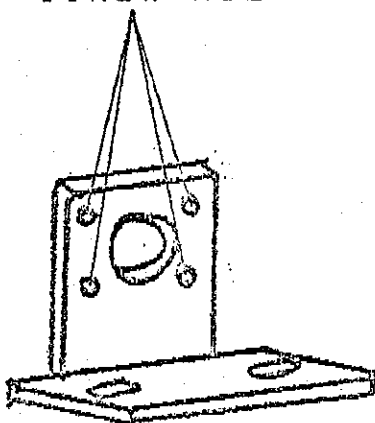

AU2803A-238J

"3" SCREW HOLES

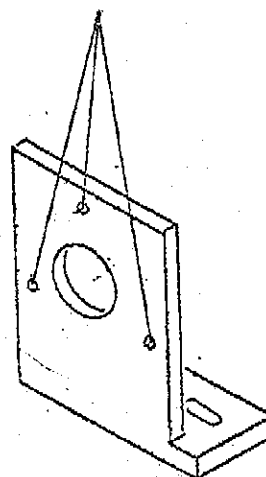

REMARK: WHEN ORDERING, PLEASE GET A INFORMATION FROM THE CUSTOMER WHICH TYPE OF ABOVE PART IS INSTALLED ON THE MACHINE, "4" SCREW HOLES OR "3" SCREW HOLES.

PARTS INFORMATION

NO.005 02/25/93

AU2803A-189 FIXED FINGER, LEFT

AU2803A-189A

LARGE PALM,  
NARROW FINGER

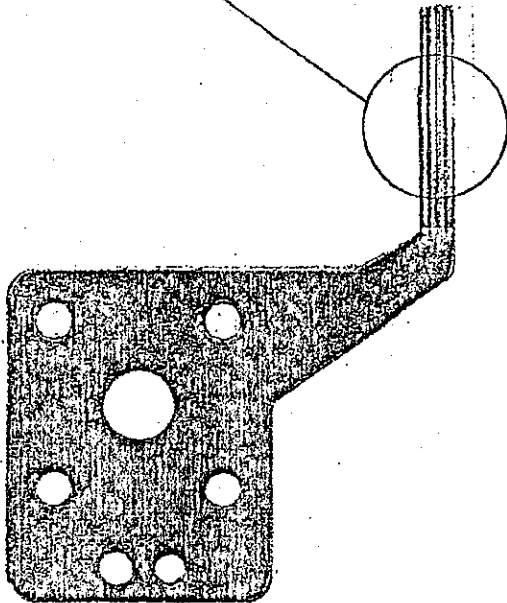

AU2803A-189B

LARGE PALM,  
WIDE FINGER

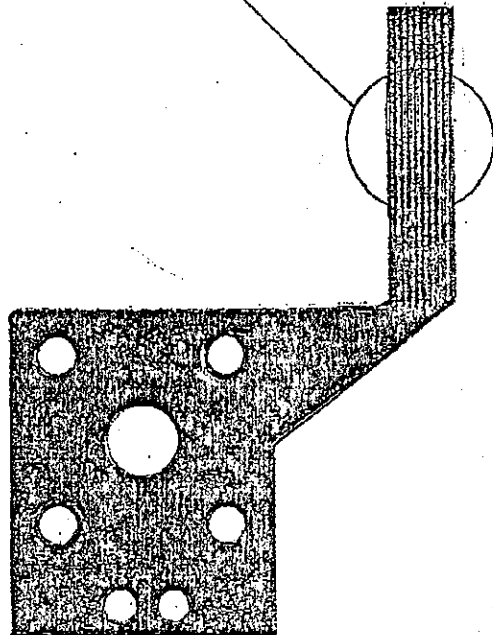

REMARK: WHEN ORDERING, PLEASE GET A INFORMATION FROM THE CUSTOMER WHICH TYPE OF ABOVE PART IS INSTALLED ON THE MACHINE. NARROW FINGER OR WIDE FINGER.

**PARTS INFORMATION**

NO.006 02/25/93

**AU2803A-185 FIXED FINGER, RIGHT**

**AU2803A-185A**

LARGE PALM,  
NARROW FINGER

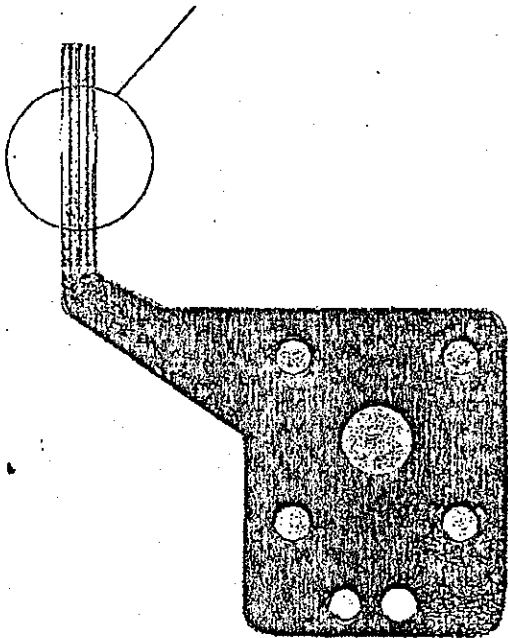

**AU2803A-185B**

LARGE PALM,  
WIDE FINGER

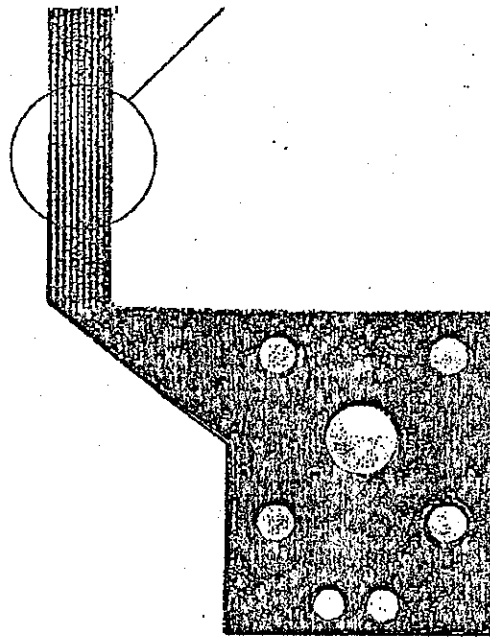

REMARK: WHEN ORDERING, PLEASE GET A INFORMATION FROM THE CUSTOMER WHICH TYPE OF ABOVE PART IS INSTALLED ON THE MACHINE, NARROW FINGER OR WIDE FINGER.

PARTS INFORMATION

NO.007 02/25/93

AU2803A-417 FIXED FINGER, LEFT

AU2803A-417A

SMALL PALM,  
WIDE FINGER,  
3mm SCREW HOLE

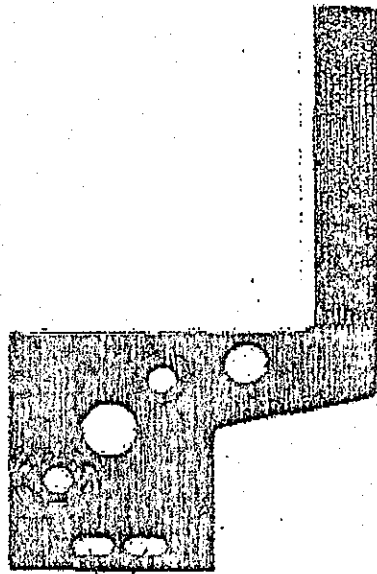

3mm

AU2803A-417B

SMALL PALM,  
WIDE FINGER,  
4mm SCREW HOLE

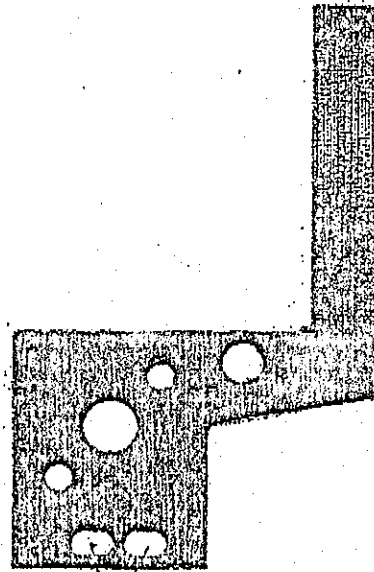

4mm

REMARK: WHEN ORDERING, PLEASE GET A INFORMATION FROM THE CUSTOMER WHICH TYPE OF ABOVE PART IS INSTALLED ON THE MACHINE, 3mm SCREW HOLE OR 4mm SCREW HOLE.

PARTS INFORMATION

NO.008 02/25/93

AU2803A-421 FIXED FINGER, RIGHT

AU2803A-421A

SMALL PALM,  
WIDE FINGER,  
3mm SCREW HOLE

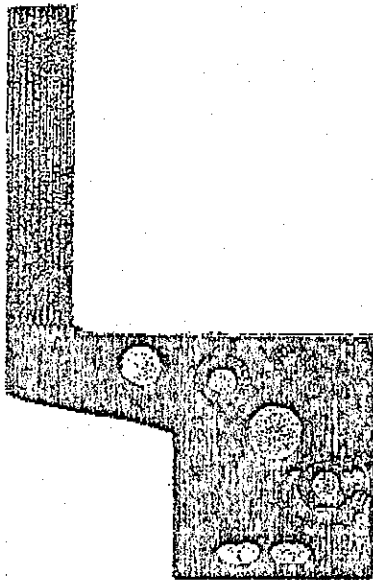

3 mm

AU2803A-421B

SMALL PALM,  
WIDE FINGER,  
4mm SCREW HOLE

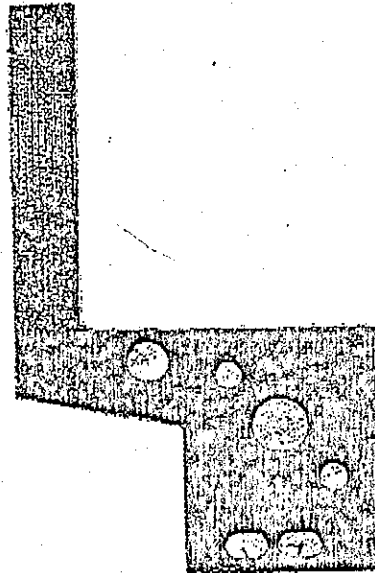

4 mm

REMARK: WHEN ORDERING, PLEASE GET A INFORMATION FROM THE CUSTOMER WHICH TYPE OF ABOVE PART IS INSTALLED ON THE MACHINE, 3mm SCREW HOLE OR 4mm SCREW HOLE.



PARTS INFORMATION

NO.009 02/25/93

AU2803A-190 MOVABLE FINGER, LEFT

AU2803A-190A

LARGE PALM,  
NARROW FINGER,

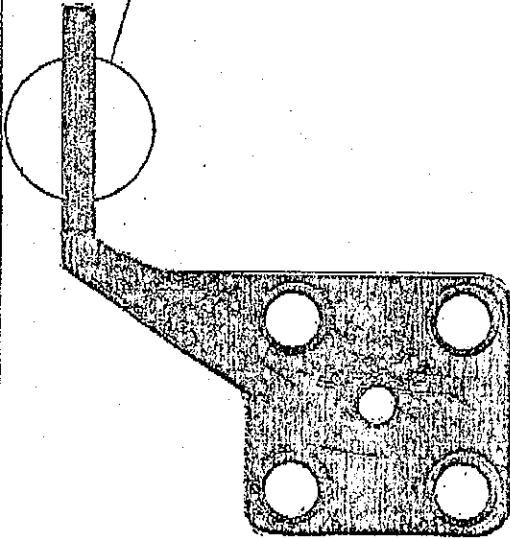

AU2803A-190B

LARGE PALM,  
WIDE FINGER,

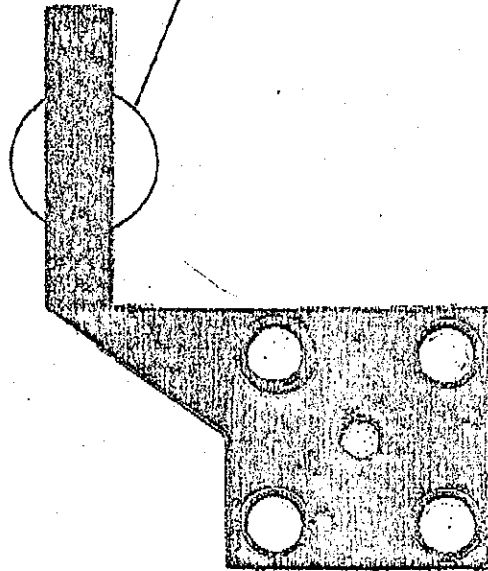

REMARK: WHEN ORDERING, PLEASE GET A INFORMATION FROM THE CUSTOMER WHICH TYPE OF ABOVE PART IS INSTALLED ON THE MACHINE, NARROW FINGER OR WIDE FINGER.

PARTS INFORMATION

NO.010 03/01/93

AU2803A-414 TRANSFORMER

AU2803A-414A

for 220V, 3PH

AU2803A-414B

for 200V, 3PH  
220V, 3PH  
240V, 3PH  
380V, 3PH

[STANDARD]

REMARK: WHEN ORDERING, PLEASE SPECIFY WHICH ONE YOU NEED, EXCLUSIVE FOR 220V  
OR STANDARD WICH COVERS ALL VOLTAGES IN THE WORLD.

2/5

PARTS INFORMATION

NO.011 03/02/93

AU2803A-32 DRIVE SHOE/COLLAR

AU2803A-32F

AU2803A-32J

DRIVE SHOE  
(for 2800AUF)

COLLAR  
(for 2800AUJ)

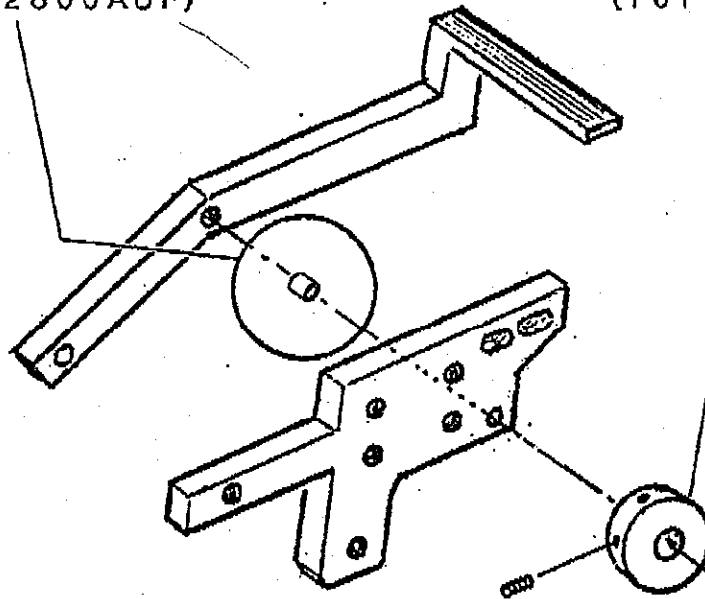

REMARK: WHEN ORDERING, PLEASE SPECIFY WHICH ONE YOU NEED, DRIVE SHOE OR COLLAR.

UNION SPECIAL JAPAN LTD.

**PARTS INFORMATION**

NO.012 03/03/93

**AU2803A-191 MOVABLE FINGER, RIGHT**

**AU2803A-191A**

LARGE PALM,  
NARROW FINGER,

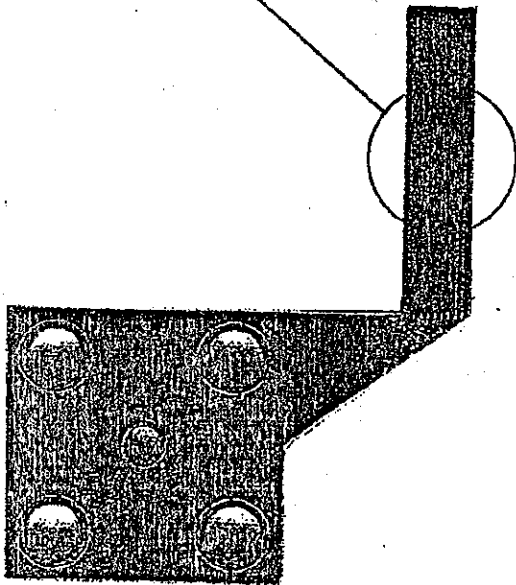

**AU2803A-191B**

LARGE PALM,  
WIDE FINGER

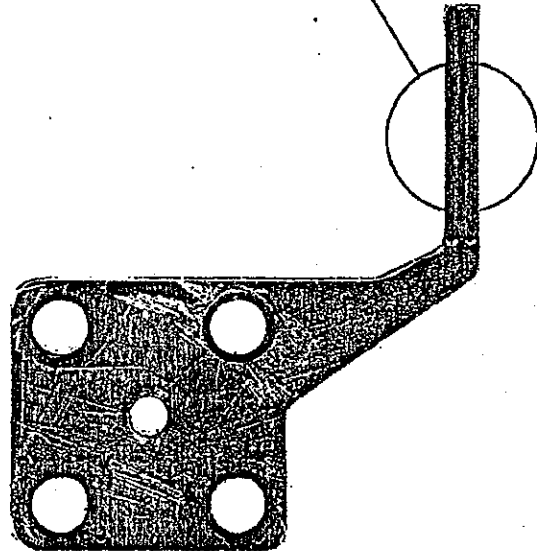

REMARK: WHEN ORDERING, PLEASE GET A INFORMATION FROM THE CUSTOMER WHICH TYPE OF ABOVE PART IS INSTALLED ON THE MACHINE, NARROW FINGER OR WIDE FINGER.

**PARTS INFORMATION**

NO.015 05/13/93

**AU2803A-395 BOBBIN CHANGE COUNTER**

**AU2803A-395F**

HOKUYO  
ACNHB-4 AC100V

**AU2803A-395J**

HOKUYO  
ACNKB-4 AC100V

||  
[ SAME AS AU2803A-403  
TOTAL COUNTER ]

REMARK: WHEN ORDERING, PLEASE GET A INFORMATION FROM THE CUSTOMER WHICH NUMBER IS INDICATED ON THEIR PART. ACNHB-4 OR ACNKB-4.

**PARTS INFORMATION**

NO.018 07/15/93

**AU2803A-269**  
(for AUJ-3)

**AU2803A-269L**  
(for AUJ-50)

**AU2803A-269L GUIDE PLATE**  
(for AUJ-3 & AUJ-50)

REMARK: AU2803A-269 (GUIDE PLATE FOR 2800AUJ-3) WAS DISCONTINUED AND REPLACED BY AU2803A-269L.

*Melonee*