

**SINGER**  
95-84

# LIST OF PARTS



## MACHINE No. 95-84

THE SINGER MANUFACTURING COMPANY

### INDEX

---

	Page
Accessories.....	15
Bobbin Winders.....	15
Finger Guard.....	17
Foot Lifter Parts.....	17
Knee Lifter Parts.....	18
Machine Base.....	19
Machine No. 95-84.....	7
Numerical List of Parts.....	23
Thread Stabilizer.....	20
Thread Unwinder.....	20
Yoking Attachment.....	21

# INSTRUCTIONS FOR ORDERING

INSTRUCTIONS FOR ORDERING - Continued

In ordering from this list, use ONLY the part NUMBER in the FIRST column.

The number stamped on a Sewing Machine Part is in every case the number of the single part only.

Every combination of parts sent out as such has its specific number, which, although not stamped on the parts, must be used when ordering the combination.

Each number always indicates the SAME PART in whatever list it appears, or for whatever machine.

The letters after some of the numbers indicate the style of finish only, as follows:

A-Hardened, Polished, Nickel Plated and Buffed  
A.A-Buffed and Chromium Plated  
A.B-Hardened, Polished, Buffed and Chromium Plated  
A.C-Brown Baking Enamel Finish  
A.D-Gray Baking Enamel Finish  
A.E-Hardened, Bright Rumbled and Nickel Plated  
A.F-Hardened, Bright Rumbled, Nickel Plated, Bright Rumbled and Chromium Plated  
A.G-Alumilite, Plain  
A.H-Alumilite, Dyed  
A.J-Polished, Nickel Plated and Chromium Plated  
A.K-Hardened, Polished, Nickel Plated and Chromium Plated  
A.L-Heat Treated for Toughness  
B-Polished, Nickel Plated and Buffed  
C-Hardened Only  
C.R-Hardened and Merlized  
D-Polished Only  
E-Soft, Not Polished  
F-Hardened and Polished  
F.J-Hardened, Polished and Nickel Plated  
G-Bright Rumbled and Nickel Plated  
H-Blued  
J-Nickel Plated Only  
K-Hardened and Nickel Plated  
L-Brass Plated  
M-Oxidized  
N-Japanned, Dull  
P-Japanned, Bright  
P.P-Wrinkle Finish  
R-Merlized  
S-Cadmium Plated  
T-Copper Plated  
T.A-Hardened, Polished, Copper and Nickel Plated and Buffed  
T.B-Copper and Nickel Plated and Polished  
T.J-Copper and Nickel Plated Only  
T.K-Hardened, Copper and Nickel Plated  
T.L-Copper and Brass Plated  
T.M-Copper Plated and Oxidized

U-Zinc Plated  
V-Silver Plated  
W-Polished and Nickel Plated  
X-Black Oxide, for Iron and Steel  
X.C-Hardened and Black Oxide, for Iron or Steel  
Y-Black Nickel Plated Only  
Z-Chromium Plated  
Z.A-Hardened, Polished, Nickel Plated, Buffed and Chromium Plated  
Z.B-Polished, Nickel Plated, Buffed and Chromium Plated  
Z.C-Hardened and Chromium Plated  
Z.D-Polished and Chromium Plated  
Z.G-Bright Rumbled, Nickel Plated, Bright Rumbled and Chromium Plated  
Z.J-Nickel and Chromium Plated  
Z.T-Copper and Chromium Plated

These letters MUST BE USED when they appear in the list; and AFTER the number as in the list.

In this series:

1 to 1500, 50001 to 51500 and 140001 to 142000 are Screw Numbers  
1501 to 1800 and 51501 to 51800 are Nut Numbers  
1801 to 2000 and 51801 to 52000 are Roller Numbers  
2001 to 50000 and 52001 to 140000 and 142001 to 190000 are Sewing Machine Parts, 190001 and upward are numbers of Electrical Parts.

The figures in the second column refer only to the plates, illustrating the parts, and are NOT TO BE USED in ordering.

Parts marked with an asterisk (\*) are furnished only when repairs are made at factory.

LIST OF PARTS COMPLETE  
FOR

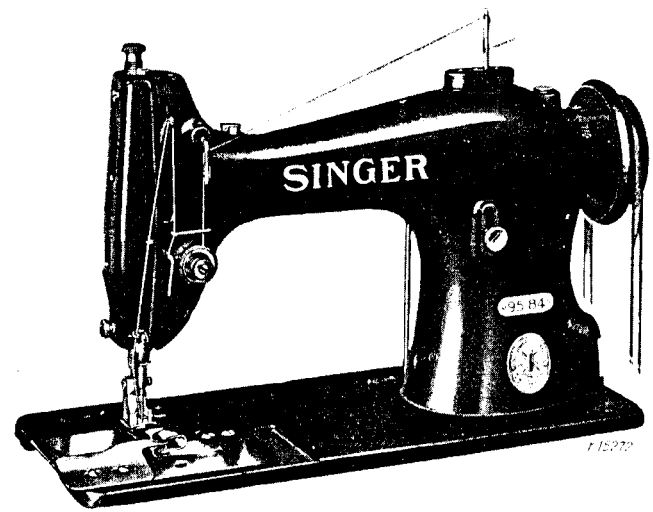

MACHINE No. 95-84

FOR SHOULDER JOINING ON SHIRTS. MAXIMUM STITCH SEVEN TO THE INCH. HEAVY GEAR SHAFTS AND THREE PLAIN BEARINGS FOR THE ARM SHAFT. GEARS ARE LUBRICATED WITH GREASE APPLIED WITH HAND PRESSURE GREASE GUN. NEEDLE BAR STROKE 1<sup>9</sup>/<sub>64</sub> INCHES. SPEED 4000 R. P. M.

No.	Plate	Name
*52252	-----	Arm with 15404 and two each 15405 and 56015.....
		Note: Due to the accuracy required for gear alignment, Arm cannot be supplied separately and can only be sent out as a unit, Arm and Bed assembled.
16532	21895	Arm Dowel Pin (2).....
52182	21895	" Oil Tube with 52184, for oiling 127231.....
52183	21895	Arm Oil Tube with 52184, for oiling 52024 and 127156, for 127193....
52180	21895	Arm Oil Tube (long) with 52184, for oiling 52022.....

Genuine "SINGER" Needles should be used in "SINGER" Machines. These Needles and their Containers are marked with the Company's Trade Mark "SIMANCO" 1

Needles in Containers marked "FOR SINGER MACHINES" are NOT "SINGER" made needles. 2

## PARTS FOR MACHINE No. 95-84

No.	Plate	Name
52185	21895	Arm Oil Tube (short) with 42367, for oiling 52022.....
127187	21895	Arm Oil Tube (bent) with 42367, for oiling 127152, for 127193.....
56015	21895	Arm Oil Tube for oiling 142006 (2).....
52254	21895	" " " " " 52262.....
52290	21895	" " " " " Hole Plug.....
42367	21895	" " " " " Packing (braided cotton) for 52185 and 127187 (2).....
52184	21895	Arm Oil Tube Packing (wick) for 52180, 52182 and 52183 (3).....
116E	21895	Arm Screw (back) (2).....
868E	21895	" " (front) (2).....
52255	21892	" Shaft (horizontal).....
52256	-----	" " " " " 52255 with 52196 and 52246.....
54897	21895	Arm Shaft (horizontal) Back Bearing Oil Cup.....
127072	21892	Arm Shaft (horizontal) Bevel Gear with two 1036AL.....
142003	21892	Arm Shaft (horizontal) Bevel Gear Case (two pieces) with 51068R, 140184E and 142005.....
142005	21892	Arm Shaft (horizontal) Bevel Gear Case Alemite Fitting.....
140184E	21892	Arm Shaft (horizontal) Bevel Gear Case Plug Screw.....
51068R	21892	Arm Shaft (horizontal) Bevel Gear Case Screw.....
1036AL	21892	Arm Shaft (horizontal) Bevel Gear Set Screw (2).....
52260	21892	Arm Shaft (horizontal) Flanged Bushing (back) with 52193 and 52289.....
52193	21892	Arm Shaft (horizontal) Flanged Bushing (back) Oil Pad (inside) braided cotton.....
52289	21892	Arm Shaft (horizontal) Flanged Bushing (back) Oil Pad (outside) felt.....
448AL	21892	Arm Shaft (horizontal) Flanged Bushing (back) Set Screw.....
52196	21892	Arm Shaft (horizontal) Flanged Bushing (front) with 52193 and 52198.....
52193	21892	Arm Shaft (horizontal) Flanged Bushing (front) Oil Pad (inside) braided cotton.....
52198	21892	Arm Shaft (horizontal) Flanged Bushing (front) Oil Pad (outside) felt.....
435AL	21892	Arm Shaft (horizontal) Flanged Bushing (front) Set Screw.....
68350	21895	Arm Shaft (horizontal) Front Bearing Oil Cup.....
52262	21892	Arm Shaft (horizontal) Intermediate Bushing with 52193 and 52263.....

No.	Plate	Name
52193	21892	Arm Shaft (horizontal) Intermediate Bushing Oil Pad (inside) braided cotton.....
52263	21892	Arm Shaft (horizontal) Intermediate Bushing Oil Pad (outside) felt.....
423AL	21892	Arm Shaft (horizontal) Intermediate Bushing Set Screw.....
144D	21892	Arm Shaft (horizontal) Screw.....
142006	21892	" " (upright).....
52281	21892	" " " " Bevel Gear (lower) with two 1259AL.....
1259AL	21892	Arm Shaft (upright) Bevel Gear (lower) Set Screw (2).....
52282	21892	Arm Shaft (upright) Bevel Gear (upper) with two 1259AL.....
1259AL	21892	Arm Shaft (upright) Bevel Gear (upper) Set Screw (2).....
52276	21892	Arm Shaft (upright) Bushing (lower) with 52279 and 52280.....
432AL	21892	Arm Shaft (upright) Bushing (lower) Set Screw.....
52278	21892	Arm Shaft (upright) Bushing (upper) with 52279 and 52280.....
443AL	21892	Arm Shaft (upright) Bushing (upper) Set Screw.....
52280	21892	Arm Shaft (upright) Bushing Oil Pad (outside) felt (2).....
52279	21892	Arm Shaft (upright) Bushing Oil Wick (inside) braided cotton (2).....
127146	21895	Arm Side Cap.....
219J	21895	" " " " Screw.....
127079	21895	" " " " Cover.....
50053W	21895	" " " " Thumb Screw.....
52239	21895	" " " " Spool Pin and Thread Eyelet.....
8879	21895	" " " " Washer (cloth).....
127192	21895	" " " " Top Cover.....
127193	-----	" " " " 127192 with 52183, 52239, 127187 and 127255.....
127255	21895	Arm Top Cover Positioning Disc.....
158J	21895	" " " " Screw.....
52176	21892	Balance Wheel (power, disc) 2 3/16 in. pulley, for round belt with two 448AL.....
142031	-----	Balance Wheel (power, disc) outside diam. of belt groove 2.9 in. for "V" belt with two 435AL.....
	Note:	No. 52176 is regularly furnished with this Machine.
448AL	21892	Balance Wheel Set Screw for 52176 (2).....
435AL	-----	Balance Wheel Set Screw for 142031 (2).....
*142035	-----	Bed.....
	Note:	Due to the accuracy required for gear alignment, Bed cannot be supplied separately and can only be sent out as a unit, Arm and Bed assembled.

No.	Plate	Name
142036	21891	Bed Slide.....
4307	21891	" " Spring.....
725J	21891	" " " Screw (2).....
142037	21891	Bed Slide complete, Nos. 4307, 142036 and two 725J.....
52051	21891	Face Plate.....
176J	21891	" " Screw.....
52053	21891	" " Thread Guard (lower).....
226J	21891	" " " " " Screw.....
52170	21891	Face Plate Thread Guard (upper).....
226J	21891	" " " " " Screw.....
52052	-----	Face Plate complete, Nos. 52051, 52053, 52170 and two 226J.....
50190W	21891	Face Plate Thumb Screw.....
143030	21893	Feed Bar.....
5122OAL	-----	" " Adjusting Screw (2).....
1607C	-----	" " " " " Lock Nut (2).....
143185	-----	Feed Bar Body with two each 1607C and 5122OAL.....
704C	-----	Feed Bar Body Screw.....
143186	-----	Feed Bar Body Shank.....
143187	-----	Feed Bar (tilting, adjustable) com- plete, Nos. 704C, 143185 and 143186.....
		Note: No. 143030 is regularly furnished with this machine.
313C	21893	Feed Bar Screw Center (2).....
56813	-----	" " " " " 313C with 1519J (2).....
1519J	21893	Feed Bar Screw Center Nut (2).....
52165	21892	" Connecting Link.....
375C	21892	" " " Hinge Screw....
1518J	21892	" " " " " Nut
52073	21892	" " " " " Stud.....
50083AL	21892	" " " " " Set Screw.....
142038	21891	Feed Dog, 14 teeth (16 teeth to the inch) for use with 142044.....
142062	-----	Feed Dog, 17 teeth (18 teeth to the inch) for general and shirt work
50117AL	21891	Feed Dog Screw (2).....
52218	21892	" and Feed Lifting Eccentric with 448AL, 1299AL, 52210 and 52211..
52231	-----	Feed and Feed Lifting Eccentric 52218 with 127152.....
52210	-----	Feed and Feed Lifting Eccentric Lu- bricating Pad (long) wood.....
52211	-----	Feed and Feed Lifting Eccentric Lu- bricating Pad (short) wood.....
1299AL	-----	Feed and Feed Lifting Eccentric Po- sition Screw.....
448AL	21892	Feed and Feed Lifting Eccentric Set Screw.....

No.	Plate	Name
127152	21892	Feed and Feed Lifting Eccentric Sleeve.....
24037	21892	Feed Forked Connection.....
52085	-----	" " " 24037 with 375C, 1518J and 52165.....
375C	21892	Feed Forked Connection Hinge Screw..
1518J	21892	" " " " " Nut.....
52065	21893	Feed Lifting Rock Shaft.....
52264	-----	Feed Lifting Rock Shaft complete, Nos. 52065 and 52265.....
127156	21892	Feed Lifting Rock Shaft Connecting Rod with two 966E.....
966E	21892	Feed Lifting Rock Shaft Connecting Rod Cap Screw (2).....
375C	21892	Feed Lifting Rock Shaft Connecting Rod Hinge Screw.....
1518J	21892	Feed Lifting Rock Shaft Connecting Rod Hinge Screw Nut.....
52265	21893	Feed Lifting Rock Shaft Crank with 157J and 52267.....
157J	21893	Feed Lifting Rock Shaft Crank Clamp- ing Screw.....
52267	21893	Feed Lifting Rock Shaft Crank Slide Block.....
50191C	21893	Feed Lifting Rock Shaft Screw Center (2).....
52097	-----	Feed Lifting Rock Shaft Screw Center 50191C with 1513J (2).....
1513J	21893	Feed Lifting Rock Shaft Screw Center Nut (2).....
52074	21892	Feed Regulator with 50083AL.....
52118	-----	" " 52074 with 52073....
52093	-----	" " 52118 with 818D.....
1128E	21892	" " Hinge Screw.....
818D	21892	" " Thumb Screw.....
52068	21893	" Rock Shaft.....
52069	-----	Feed Rock Shaft complete, Nos. 29633 and 52068.....
29633	21893	Feed Rock Shaft Crank with 157J....
157J	21893	" " " " Clamping Screw
50191C	21893	" " " " Screw Center (2)....
52097	-----	" " " " " 50191C with 1513J (2).....
1513J	21893	Feed Rock Shaft Screw Center Nut (2)
25878	21896	Guide.....
50190W	-----	" Thumb Screw.....
52155	21894	Needle Bar (hollow) with 857AL.....
52268	21894	" " Bushing (lower).....
1133AL	21894	" " " " Set Screw
52014	21894	" " " " (upper).....
1133AL	21894	" " " " Set Screw
127231	21894	" " Connecting Link with 52207.....
127232	-----	Needle Bar Connecting Link 127231 with 24041.....

No.	Plate	Name
775E	21894	Needle Bar Connecting Link Cap Screw
52207	21894	" " " " Lubri- cating Pad (wood).....
24041	21894	Needle Bar Connecting Stud with 207E
207E	21894	" " " " Clamping Screw.....
52246	21892	Needle Bar Crank with 1036AL, 1037C and 1065AL.....
1065AL	21892	Needle Bar Crank Position Screw.....
857AL	21894	" Set Screw.....
127133	21895	Oil Tube with 52045.....
127091	21895	" " Bracket.....
52167	21895	" " " 127091 with 127133, for oiling Feed Connecting Link.
52045	21895	Oil Tube Packing (wick).....
12391	21894	Presser Bar (hollow).....
52338	21894	" " Guide Bracket with 223C and 453AL.....
453AL	21894	Presser Bar Guide Bracket Set Screw.
52016	21894	" " Lifter.....
689C	21894	" " " Hinge Screw.....
1520J	21894	" " " " Nut..
12327	21894	" " Lifting and Releasing Lever Bracket.....
127108	21894	Presser Bar Spring.....
11170	21894	" " " Washer.....
142039	21891	" Foot Body.....
142040	21891	" " Compensating Plate (right).....
26276	21891	Presser Foot Compensating Plate (right) Hinge Pin.....
142041	21891	Presser Foot Compensating Plate (right) Shank.....
233J	21891	Presser Foot Compensating Plate (right) Shank Screw.....
131534	-----	Presser Foot Compensating Plate (right) Spring.....
142042	21891	Presser Foot Edge Guide.....
240J	21891	" " " " Screw.....
142043	21891	Presser Foot complete with Hinged Compensating Plate at right side, Nos. 233J, 240J, 26276, 131534 and 142039 to 142042.....
140390AL	21894	Presser Foot Screw.....
688W	21894	Pressure Regulating Thumb Screw.....
144828	21894	Rotating Hook with three 1253AL.....
144829	21894	" " 144828 with 270083 and four 1053E.....
144830	-----	Rotating Hook 144829 with 40274, 143346 and three 1367E.....
144831	-----	Rotating Hook 144829 with 40274 and three 1367E (for Agents only)...
144832	21893	Rotating Hook 144830 with 52237.....
40264	21894	" " Bobbin.....
52235	21894	" " " Case.....

No.	Plate	Name
52236	-----	Rotating Hook Bobbin Case 52235 with 591F, 1380E and 40394.....
40393	-----	Rotating Hook Bobbin Case Hinge, Nos. 2974, 40392 and 125320.....
40392	21894	Rotating Hook Bobbin Case Latch.....
125320	21894	" " " " " Lever.....
2974	21894	Rotating Hook Bobbin Case Latch Lever Fulcrum Pin.....
2975	21894	Rotating Hook Bobbin Case Latch Spring.....
592E	21894	Rotating Hook Bobbin Case Latch Stop Screw.....
591F	21894	Rotating Hook Bobbin Case Tension Regulating Screw.....
40394	21894	Rotating Hook Bobbin Case Tension Spring.....
1380E	21894	Rotating Hook Bobbin Case Tension Spring Screw.....
52237	21894	Rotating Hook Bobbin Case complete, Nos. 592E, 2975, 40393 and 52236
143253	-----	Rotating Hook Bobbin Case 52237 with 143346.....
143346	21894	Rotating Hook Bobbin Case Holder....
52013	21893	" " " " " Po- sition Bracket.....
704J	21893	Rotating Hook Bobbin Case Holder Po- sition Bracket Screw.....
40274	21894	Rotating Hook Section.....
1367E	21894	" " " Screw (3).....
1253AL	21894	" " Set Screw (3).....
142007	21893	" " Shaft.....
127073	21893	" " " Bevel Gear with two 1259AL.....
142004	21893	Rotating Hook Shaft Bevel Gear Case (two pieces) with 51068R, 140184E and 142005.....
142005	21893	Rotating Hook Shaft Bevel Gear Case Alemite Fitting.....
140184E	21893	Rotating Hook Shaft Bevel Gear Case Plug Screw.....
51068R	21893	Rotating Hook Shaft Bevel Gear Case Screw.....
1259AL	21893	Rotating Hook Shaft Bevel Gear Set Screw (2).....
52286	21893	Rotating Hook Shaft Bushing (back) with 52279 and 52280.....
1148AL	21893	Rotating Hook Shaft Bushing (back) Set Screw.....
52288	21893	Rotating Hook Shaft Bushing (front) with 52279 and 52280.....
142008	21893	Rotating Hook Shaft Bushing (front) Oil Cup.....
1148AL	21893	Rotating Hook Shaft Bushing (front) Set Screw.....
52279	21893	Rotating Hook Shaft Bushing Oil Pad (inside) braided cotton (2).....

No.	Plate	Name
52280	21893	Rotating Hook Shaft Bushing Oil Pad (outside) Felt (2).....
270083	21894	Rotating Hook Thread Guard.....
1053E	21894	" " " " Screw (4)
52337	21894	Slack Thread Regulator.....
223C	20894	" " " Set Screw....
2102	21891	Tension Disc (2).....
1560C	21891	" Regulating Thumb Nut.....
32572	21891	" Releasing Disc.....
43944	21891	" " Lever.....
12398	21891	" " " Hinge Pin...
12329	21891	" " " Spring.....
32574	21891	" " Pin.....
13710	21891	" Spring.....
50304C	21891	" Stud.....
52098	-----	" " 50304C with 1560C.....
50305C	21891	" " Set Screw.....
52092	21891	Tension complete, Nos. 13710, 32572, 32574, 52082, 52083, 52098 and two 2102.....
52171	21894	Thread Eyelet for 52268.....
52027	21891	" Guard (side of arm).....
52454	21891	" Retainer.....
624AL	21891	" " Set Screw.....
52269	-----	Thread Take-up complete, Nos. 11204, 52025 and 52270.....
52216	21894	Thread Take-up Crank.....
52270	-----	" " " 52216 with 775E and 127232.....
1037C	21892	Thread Take-up Crank Position Screw.
1036AL	21892	" " " Set Screw.....
52022	21894	" " Lever with 52130.....
52023	21894	" " " Hinge Pin.....
52024	21894	" " " Link.....
11204	21894	" " " " Hinge Pin.
435AL	21894	" " " " " " Set Screw.....
52130	21894	Thread Take-up Lever Thread Eyelet Bushing.....
52025	-----	Thread Take-up Lever complete, Nos. 52022 to 52024.....
52082	21891	Thread Take-up Spring.....
52083	21891	" " " Regulator with 50305C.....
448AL	21891	Thread Take-up Spring Regulator Set Screw.....
142044	21891	Throat Plate, for use with 142038...
142060	-----	" " for use with 142062...
691F	21891	" " Screw (2).....
*15404	-----	Trade Mark.....
15405	-----	" " Rivet (2).....
62918	21897	Drip Pan.....

## ACCESSORIES

No.	Plate	Name
121587	22981	Grease Gun (3 oz. capacity) for Fitting No. 142005.....
121588	22931	Grease Gun (1/2 lb. capacity) for Fitting No. 142005.....
20022	22906	Machine Cushion (felt).....
27878	-----	" " Rivet.....
12361	22906	" Hinge Connection (2).....
44139	22906	" " Plate.....
44140	22906	Machine Hinge complete, Nos. 12361, 44139 and merlized wood screw 1 1/4 in. No. 14 F.H.....
41400	22906	Machine Rest Pin (wood).....
120342	22906	Oiler (copper plated) with 120343...
120343	22906	" Spout, 3 1/2 in. long.....
26026	22906	Screw Driver (large).....
26485	22906	" " (small).....
8909	22906	Wrench for 1513 and 1518.....
8908	22906	" " 1519 and 1520.....

## BOBBIN WINDERS

## BOBBIN WINDER

(SWINGING AUTOMATIC, RIGHT HAND)

FOR POWER TABLE

FOR "V" BELT

No.	Plate	Name
259428	23253	Brake (leather).....
259429	23253	" Clamp.....
200113F	23253	" " Screw.....
259662	23253	Bobbin Winder and Tension Bracket Base.....
225453	23253	Frame with 202277 and 259660.....
225454	23253	" Hinge Pin.....
202277	23253	" Oil Packing (wick).....
259660	23253	" Well Washer.....
225455	23253	" Spring.....
22456	23253	" " Plunger.....
259461	23253	Pulley with 200380C.....
200380C	23253	" Set Screw.....
225381	23253	Spindle.....
225444	23253	Stop Latch.....
200056E	23253	" " Screw.....



## BOBBIN WINDER

No.	Plate	Name
225458	23253	Stop Latch Thumb Lever.....
225459	23253	" " " " Hinge Stud...
225459	23253	" " " " Joint Stud...
202478	23253	" " Trip Lever.....
200299H	23253	" " " " Hinge Screw...
225461	23253	Tension Bracket with 201499H.....
200082D	23253	" " Screw.....
228026	23253	" " Washer.....
2102	23253	" Disc (2).....
13710	23253	" Spring.....
201499H	23253	" Stud.....
201572H	23253	" " Thumb Nut.....
225462	23253	Tension Bracket complete, Nos. 13710, 201572H, 225461 and two 2102.....
259462	23253	Bobbin Winder complete for "V" belt, Nos. 200056E, 200082D, 200113F, 200299H, 202478, 225381, 225444, 225453 to 225456, 225458, 225462, 228026, 259428, 259429, 259461, 259662, two each 225459 and wood screws 5/4 In. No. 12 R.H.....

## BOBBIN WINDER

(SWINGING AUTOMATIC, RIGHT HAND)

## FOR POWER TABLE

## FOR ROUND BELT

No.	Plate	Name
259428	23253	Brake (leather).....
259429	23253	" Clamp.....
200113F	23253	" " Screw.....
259430	23253	Bobbin Winder and Tension Bracket Base.....
225453	23253	Frame with 202277 and 259660.....
225454	23253	" Hinge Pin.....
202277	23253	" Oil Packing (wick).....
259660	23253	" " Well Washer.....
225455	23253	" Spring.....
225456	23253	" " Plunger.....
225368	23253	Pulley with 200380C.....
200380C	23253	" Set Screw.....
225381	23253	Spindle.....
225444	23253	Stop Latch.....
200056E	23253	" " Screw.....
225458	23253	" " Thumb Lever.....
225459	23253	" " " " Hinge Stud...
225459	23253	" " " " Joint Stud...
202478	23253	" " Trip Lever.....
200299H	23253	" " " " Hinge Screw...
225461	23253	Tension Bracket with 201499H.....
200082D	23253	" " Screw.....
228026	23253	" " Washer.....
2102	23253	" Disc (2).....

## BOBBIN WINDER

No.	Plate	Name
13710	23253	Tension Spring.....
201499H	23253	" Stud.....
201572H	23253	" " Thumb Nut.....
225462	23253	Tension Bracket complete, Nos. 13710, 201572H, 225461 and two 2102.....
259431	23253	Bobbin Winder (for round belt) com- plete, Nos. 200056E, 200082D, 200113F, 200299H, 202478, 225368, 225381, 225444, 225453 to 225456, 225458, 225462, 228026, 259428 to 259430, two each 225459 and wood screws 3/4 in. No. 12 R.H.B.....

## FINGER GUARD

No.	Plate	Name
212356	21895	Finger Guard.....

## FOOT LIFTER PARTS

No.	Plate	Name
5596	21893	Bell Crank.....
56848	-----	" " 5596 with 5599 and 5601..
5599	21893	" " Bracket.....
178E	21893	" " " Screw (2).....
5601	21893	" " Hinge Pin.....
5735	21893	" " Spring.....
5598	-----	Bell Crank complete, Nos. 5735 and 56848.....
5670	21873	Chain, length 26 in. to 35 in., with 56864 and 56865.....
		Note: When ordering No. 5670, state length required.
4879	21873	Chain Connecting Link.....
56864	21873	" Hook (large).....
56865	21873	" " (small).....
16510	21893	Lifting Lever with 448AL.....
52028	21893	" " Connecting Rod.....
12416	21893	" " " " Joint..
76D	21893	" " " " " "
		Hinge Screw.....
1521J	21893	Lifting Lever Connecting Rod Lock Nut.....
802D	21893	Lifting Lever Hinge Screw.....
12241	21894	" " Link.....
766E	21894	" " " Hinge Screw.....

## FOOT LIFTER PARTS

No.	Plate	Name
12240	21893	Lifting Lever Pin.....
448AL	21893	" " " Set Screw.....
2763	21873	Rock Shaft.....
12242	21873	" " Hanger with two wood screws 1 in. No. 10 (2).....
6337	21873	Rock Shaft Lifting Bracket with two 356C (2).....
12243	21873	Rock Shaft Lifting Bracket Hook.....
7125	21873	" " " " Hook.....
356C	21873	" " " " " Set Screw.....
356C	21873	Rock Shaft Lifting Bracket Set Screw
2770	21873	" " Stop Dog with 140219C....
140219C	21873	" " " " Set Screw.....
4880	21873	Rock Shaft complete, Nos. 2765, 2770, 7125, 12243 and two each 6337 and 12242.....
4881	21873	Treadle.....
4882	21873	" Shaft.....
4883	21873	" Spring.....
4884	21873	" Stand.....
4885	21873	Treadle complete, Nos. 4879, 4881 to 4884 and two wood screws 1 in. No. 16 F.H.....
52029	-----	Foot Lifter complete, Nos. 76D, 766E, 802D, 1521J, 4880, 4885, 5598, 5670, 12240, 12241, 12416, 16510, 52028 and two 178E.....

## KNEE LIFTER PARTS

No.	Plate	Name
5596	21893	Bell Crank.....
62919	-----	" " 5596 with 5601 and 62920.
62920	-----	" " Bracket.....
178E	21893	" " " Screw (2).....
5601	21893	" " Hinge Pin.....
5735	21893	" " Spring.....
62921	-----	Bell Crank complete, Nos. 5735 and 62919.....
12237	-----	Lifting Lever with 448AL.....
12415	-----	" " Connecting Rod.....
12416	21893	" " " " " Joint..
76D	21893	" " " " " " Hinge Screw.....
1521J	21893	Lifting Lever Connecting Rod Lock Nut.....
802D	21893	Lifting Lever Hinge Screw.....
12241	21894	" " Link.....
766E	21894	" " " Hinge Screw.....
12240	21893	" " Pin.....
448AL	21893	" " " Set Screw.....

## KNEE LIFTER PARTS

No.	Plate	Name
2763	24013	Rock Shaft.....
139633	-----	" " 2763 with 2770, 6337 and 139623.....
127312	24013	Rock Shaft Hanger (back) with two wood screws 1 in. No. 10 F.H. for 139624.....
12242	24013	Rock Shaft Hanger (front) with two wood screws 1 in. No. F.H. for 139624.....
7539	24014	Rock Shaft Hanger with two wood screws 1 in. No. 10 F.H., for 139625 (2).....
2765	24013	Rock Shaft Knee Arm.....
2766	24013	" " " " Hub with 356C....
356C	24013	" " " " " Set Screw...
2768	-----	Rock Shaft Knee Arm complete, Nos. 2765 to 2767.....
2767	24013	Rock Shaft Knee Plate with 356C....
356C	24013	" " " " Set Screw.....
6337	24013	" " Lifting Bracket with two 356C.....
139623	24013	Rock Shaft Lifting Bracket Hook.....
356C	21873	" " " " " Set Screw.....
356C	21873	Rock Shaft Lifting Bracket Set Screw
2770	24013	" " Stop Dog with 140219C....
140219C	24013	" " " " Set Screw.....
139624	24013	Rock Shaft complete, Nos. 2768, 12242, 127312 and 139633.....
139625	24014	Rock Shaft complete, Nos. 2768, 139633 and two 7539.....
127308	-----	Knee Lifter complete, (power table) Nos. 76D, 766E, 802D, 1521J, 12237, 12240, 12241, 12415, 12416, 62921, 139624 and two 178E.....
127309	-----	Knee Lifter complete (individual motor stand) Nos. 76D, 766E, 802D, 1521J, 12237, 12240, 12241, 12415, 12416, 62921, 139625 and two 178E.....

## MACHINE BASE

No.	Plate	Name
24106	21873	Bed Frame Cushion (felt) (4).....
158E	21873	" " " Screw (4).....
24107	21873	" " Hinge Connection (2).....
9261	21873	" " " Pin (2)..
970D	21873	" " Thumb Screw.....

No.	Plate	Name
24108	21873	Bed Frame complete, Nos. 970D, two each 9261, 24107, four each 158E, 24106 and six wood screws 1 1/4 in. No. 12 F.H.....

### THREAD STABILIZER

No.	Plate	Name
142034	21896	Thread Stabilizer.....

### THREAD UNWINDER

(FOR TWO SPOOLS OR TWO LARGE CONES OF THREAD)

No.	Plate	Name
225257	23289	Spool Rest with 201018C.....
150203	23289	" " Cushion (felt) (2).....
225388	23289	" " Rod.....
200383C	23289	" " " Set Screw.....
201018C	23289	" " Set Screw.....
259658	23289	" Stand with 200383C.....
225391	23289	Thread Guide (2).....
201696J	23289	" " Lock Nut.....
225326	23289	" " Position Cup.....
225324	23289	" " Rod with 208AL and 225322.....
208AL	23289	Thread Guide Rod Screw.....
225322	23289	" " " Washer.....
225258	23289	Thread Unwinder complete, Nos. 201696J, 225257, 225324, 225326, 225388, 259658 two each 150203, 225391 and three wood screws 7/8 in. No. 12 F.H.....
27739	23289	Thread Cone (wood) for large cones..
225390	23289	" " Holder, for inverted cones.....

Note: Nos. 27739 and 225390 are used with, but not included in 225258.

### YOKING ATTACHMENT

(ADJUSTABLE)

FOR JOINING SHOULDER OF SHIRT TO YOKE

No.	Plate	Name
121867	21896	Edge Guide.....
1443J	21896	" " Screw (2).....
121868	21896	Folder.....
121869	21896	Yoking Attachment complete, Nos. 121867, 121868 and two 1443J....
1423J	----	Yoking Attachment Screw (2).....

21873 - 1/4

Genuine "SINGER" Needles should be used  
in "SINGER" Machines.  
These Needles and their Containers  
are marked with the  
Company's Trade Mark "SIMANCO" 1

Needles in Containers marked  
"FOR SINGER MACHINES"  
are NOT "SINGER" made needles. 2

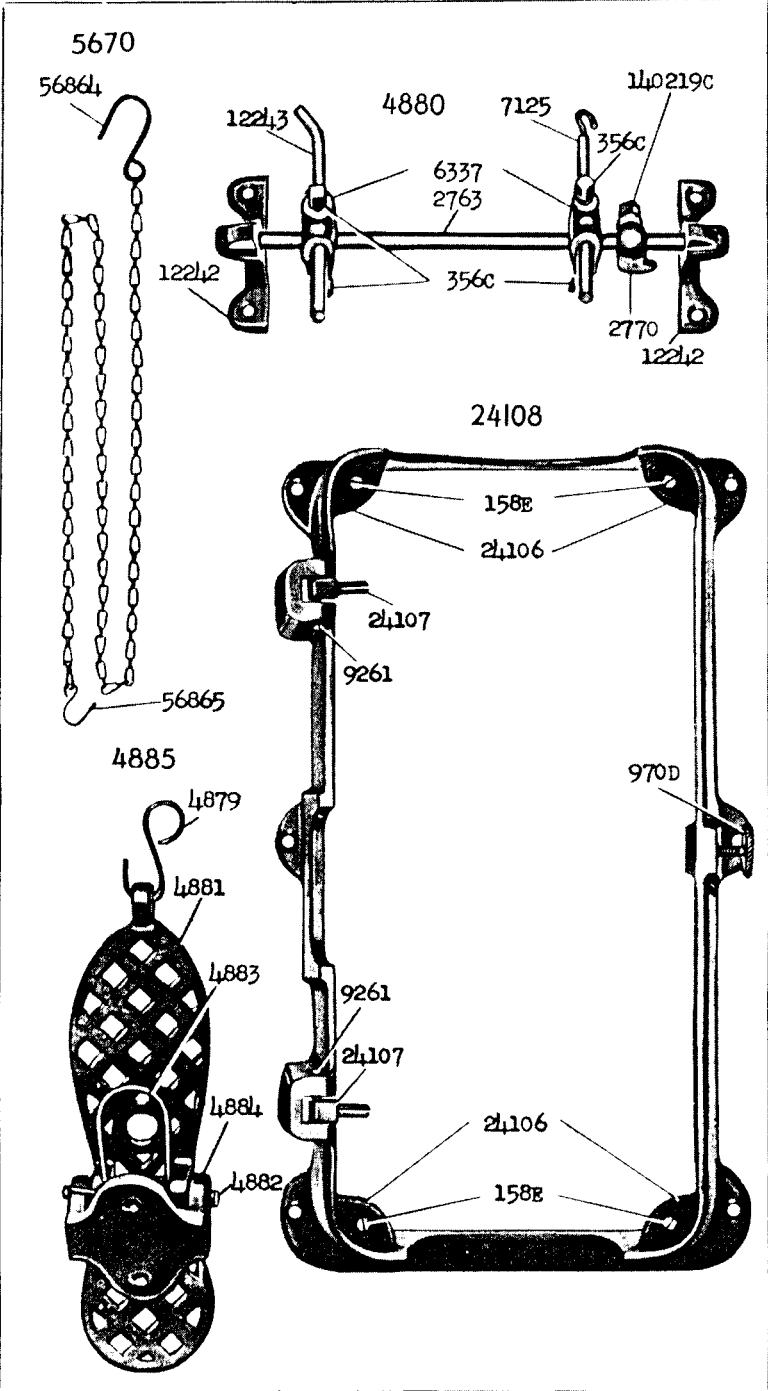

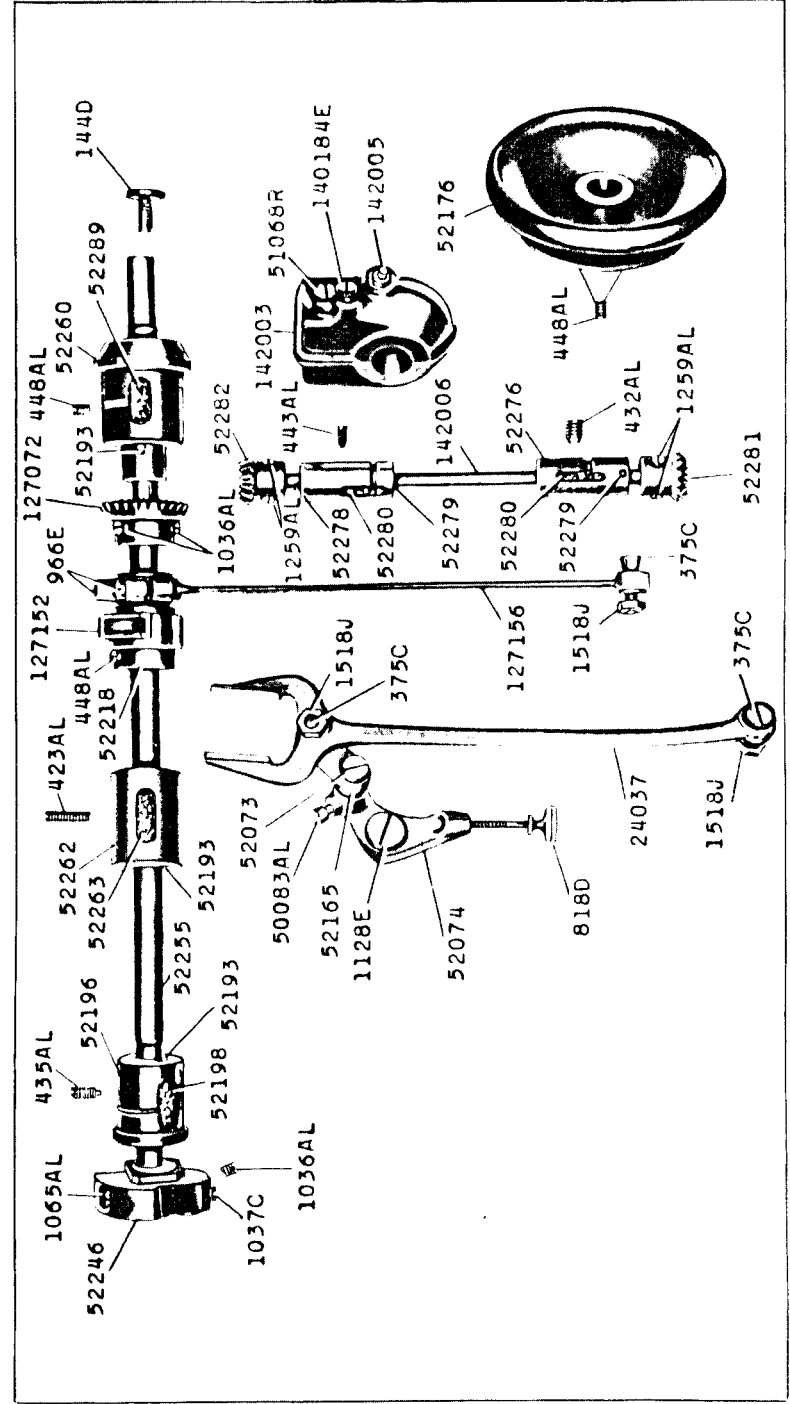
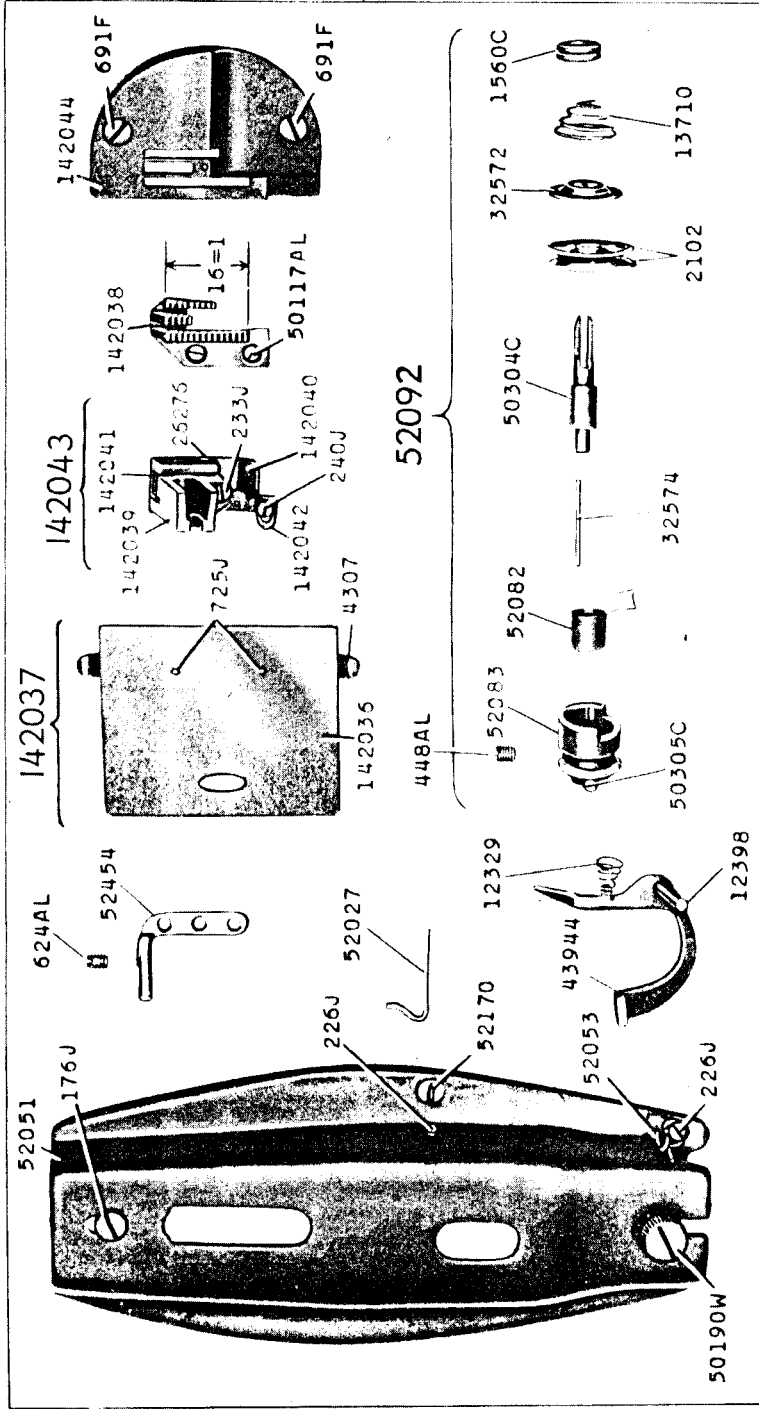

21893 - 1/3

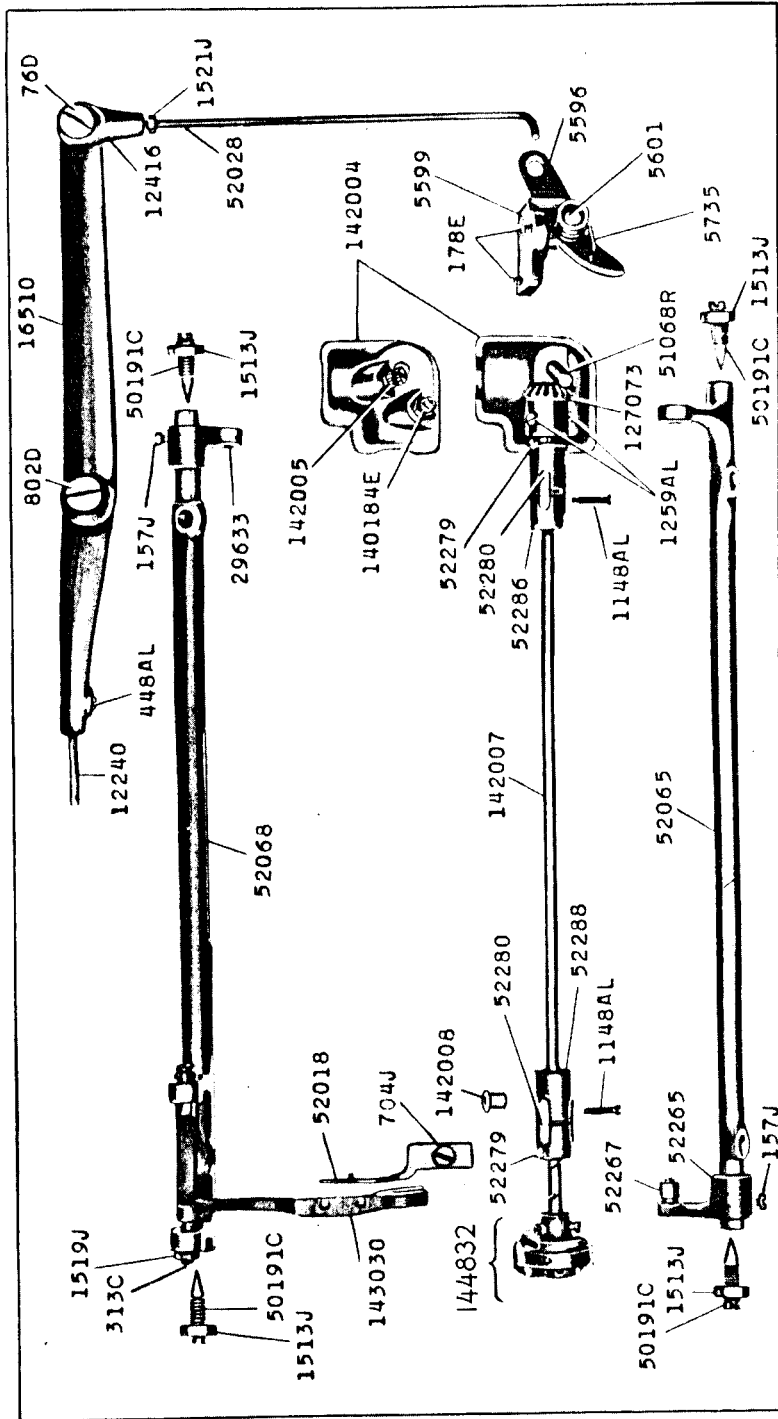

21894 - 1/2

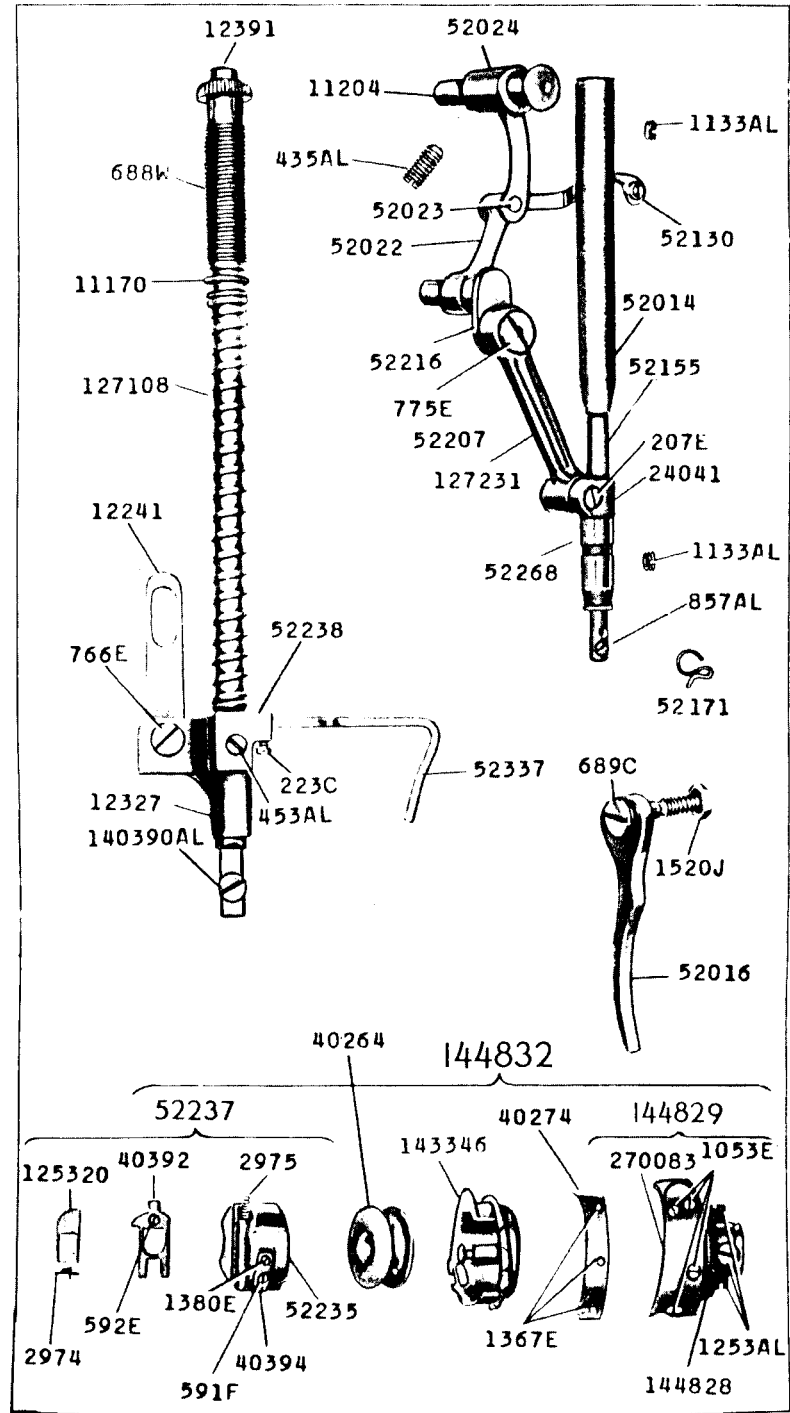

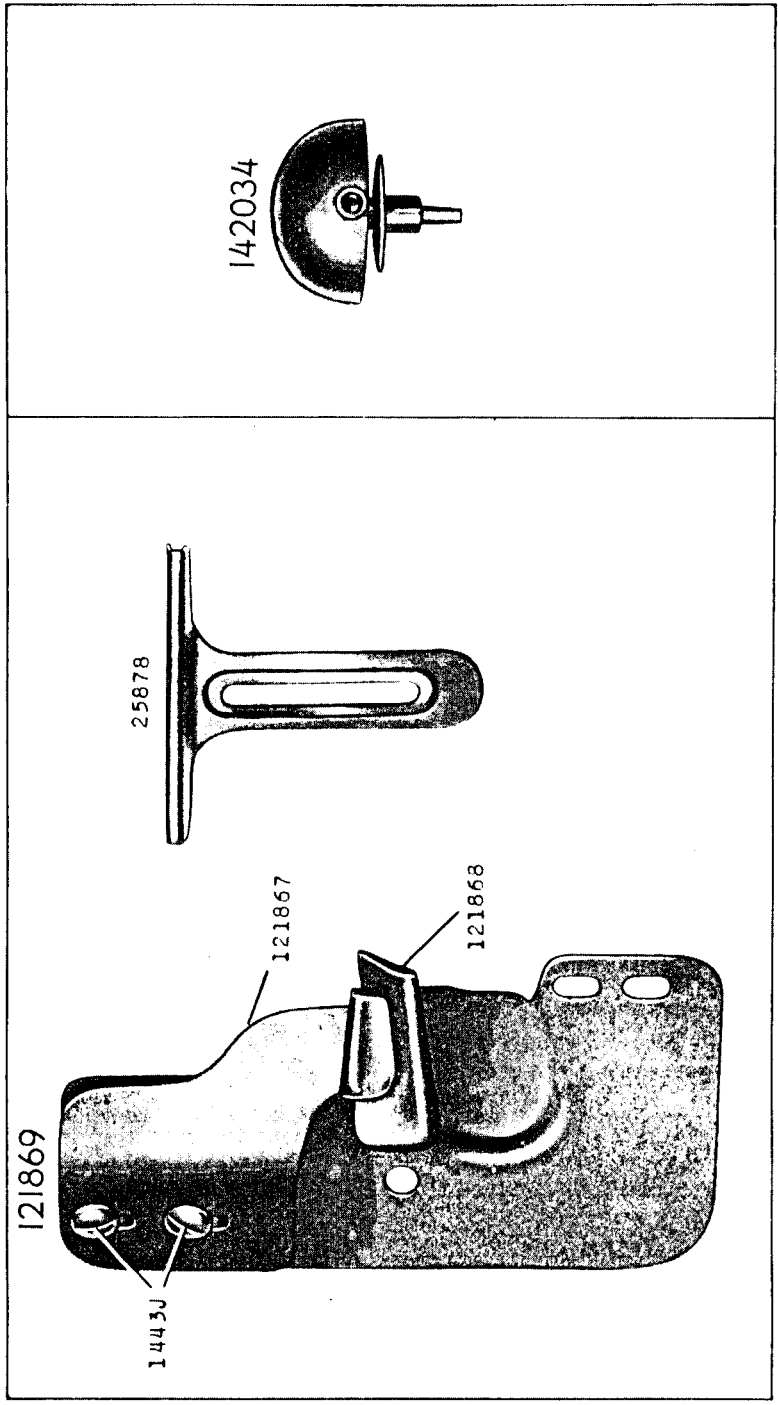
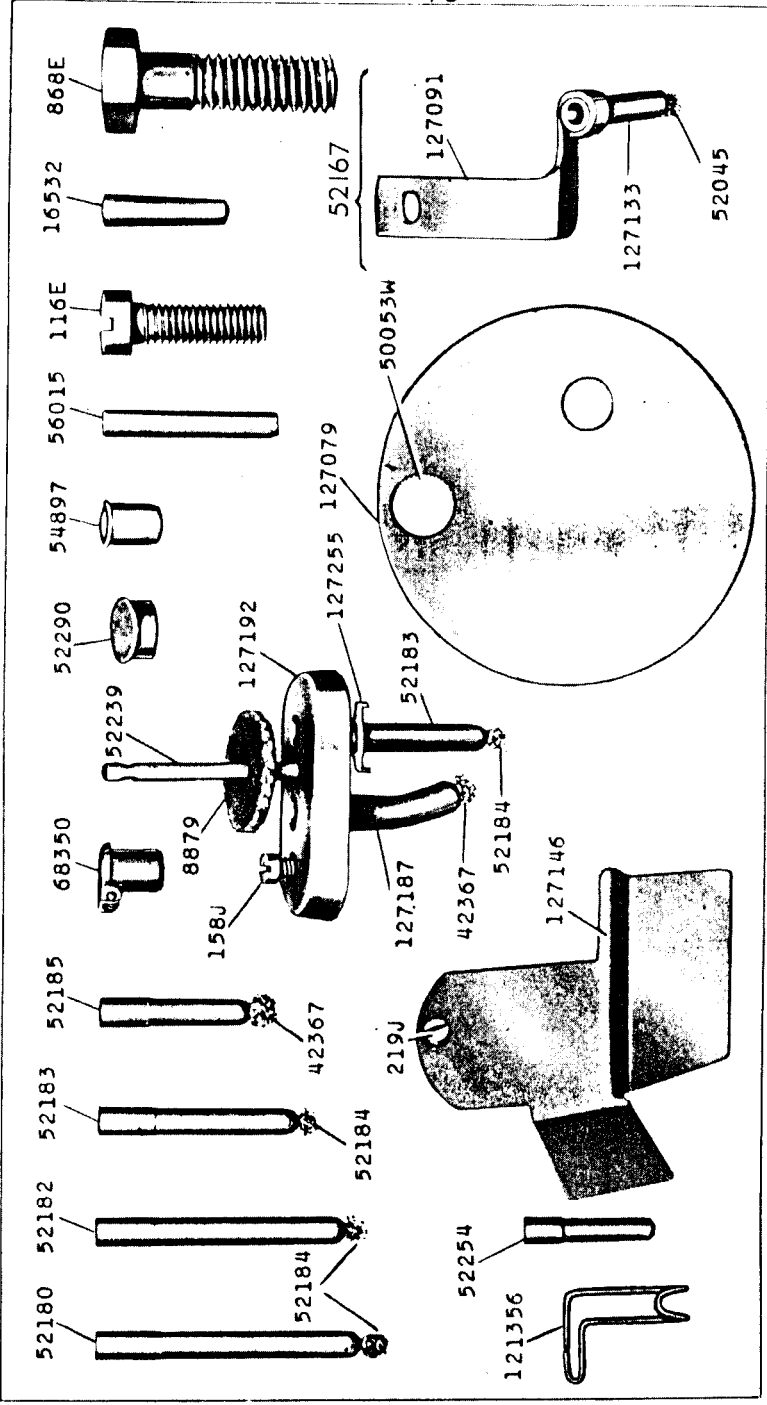

21897 - 1/4

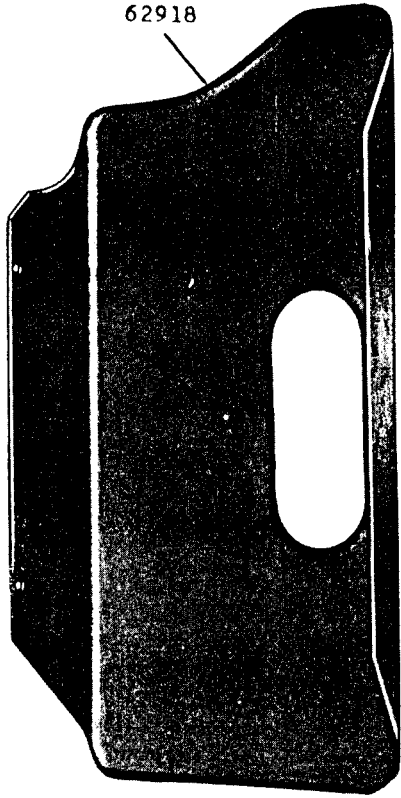

22906 - 1/2

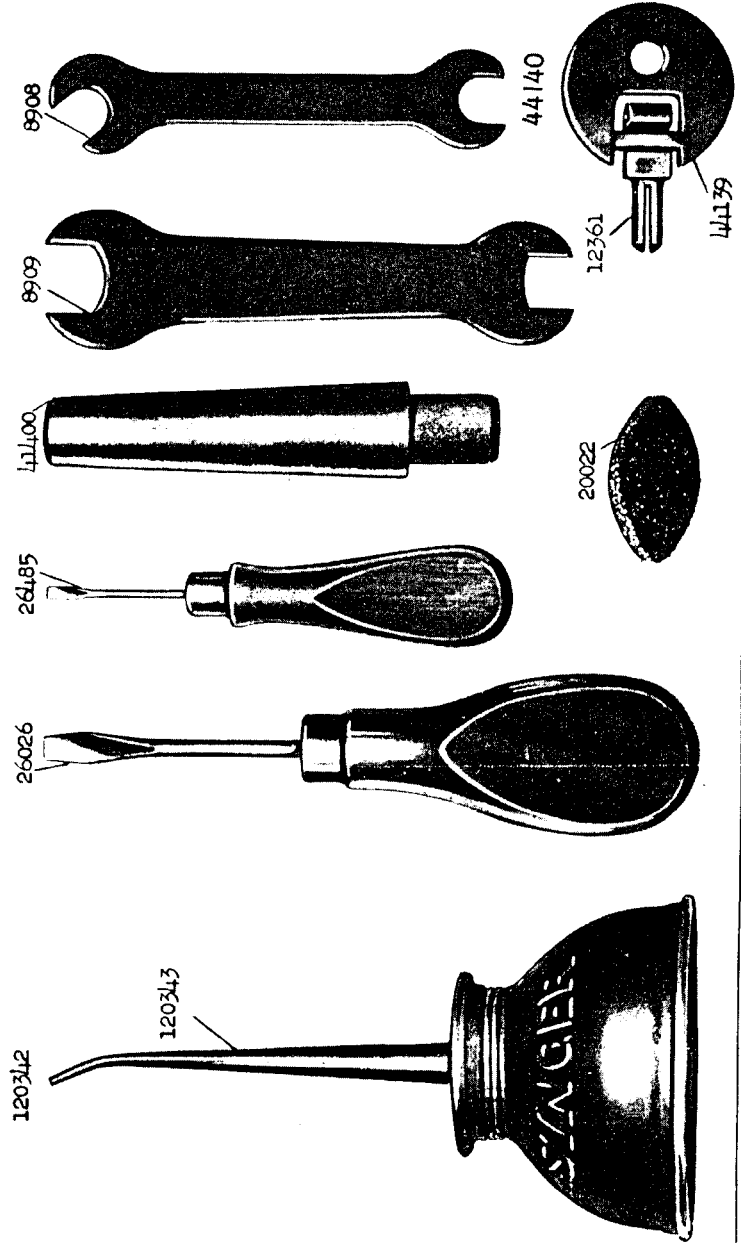



22981 - 1/2

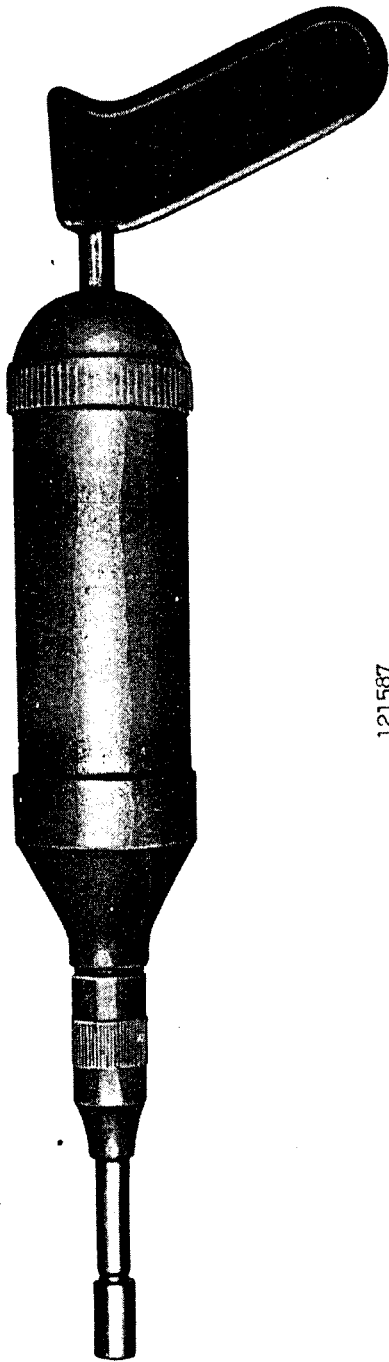

121588

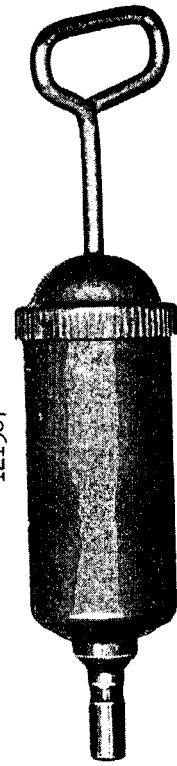

121587

23253 - 3/8

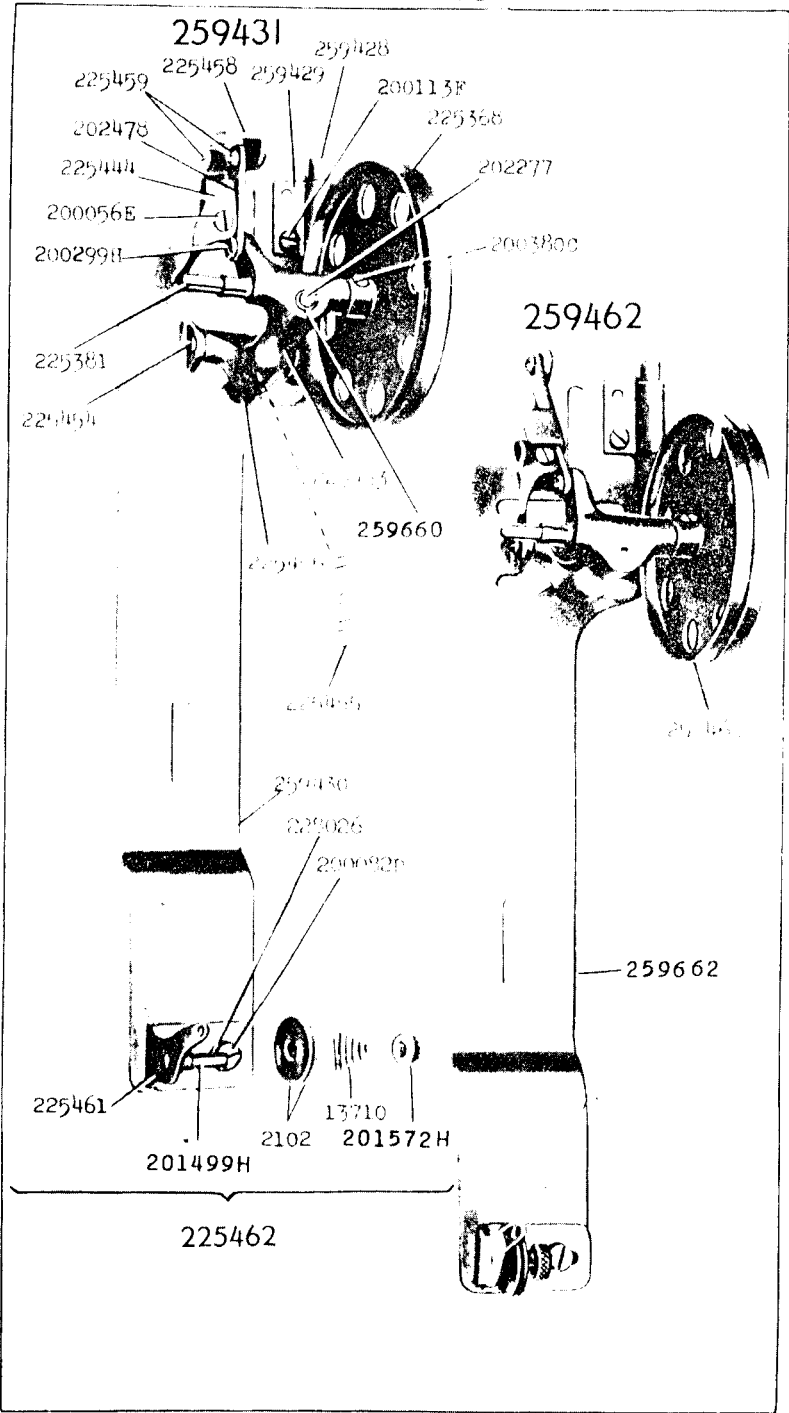

225462

23289 - 1/4

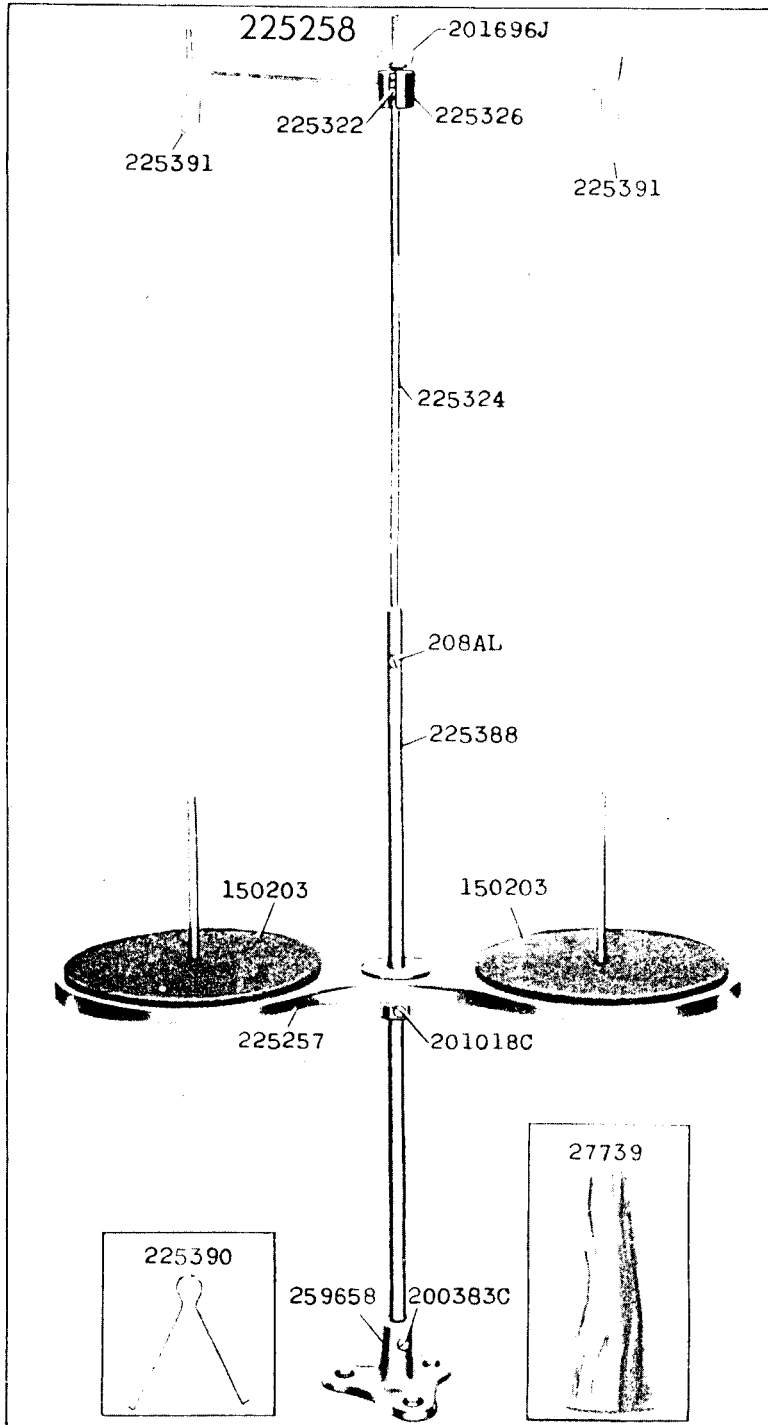

24013 - 1/2

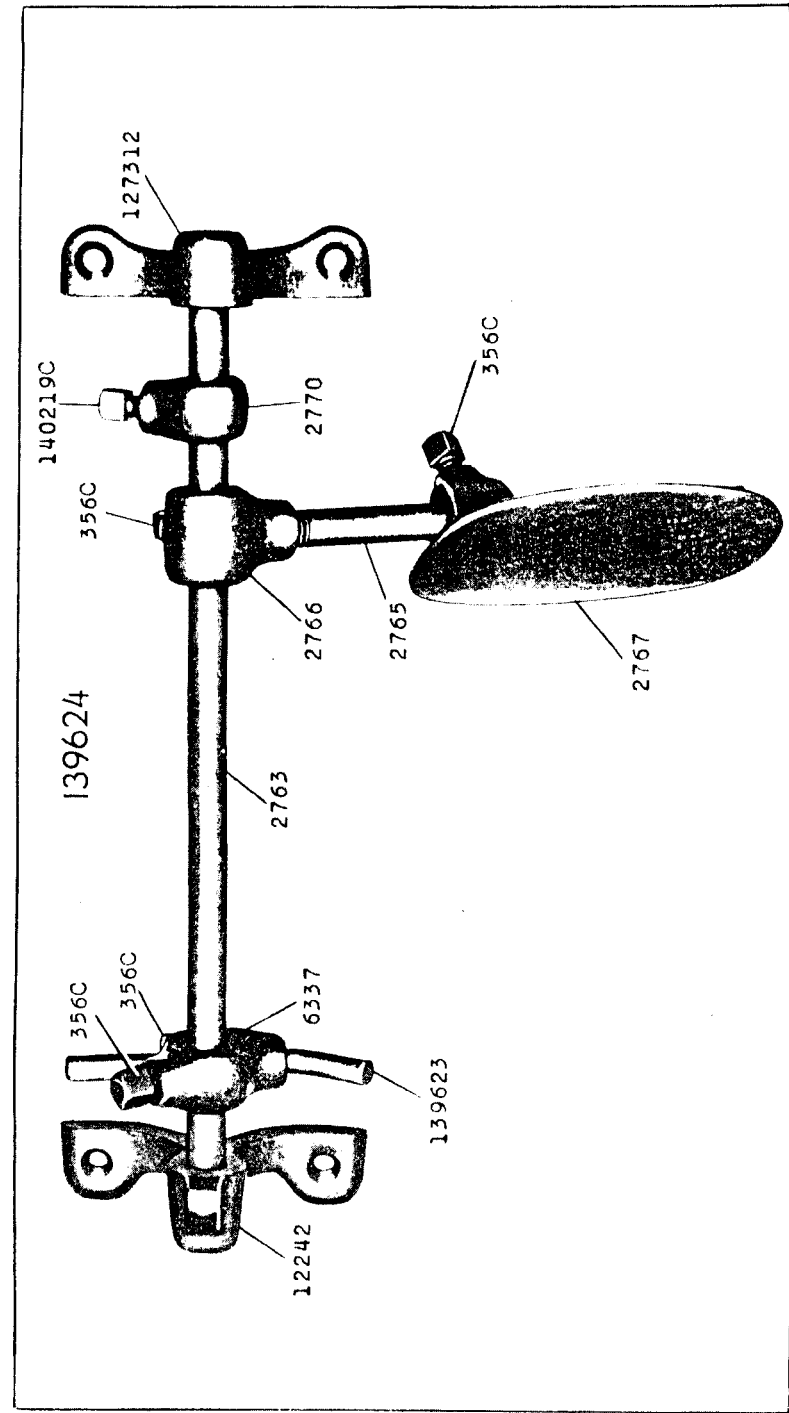

24014 - 1/2

